



STAR WARS



9493



1

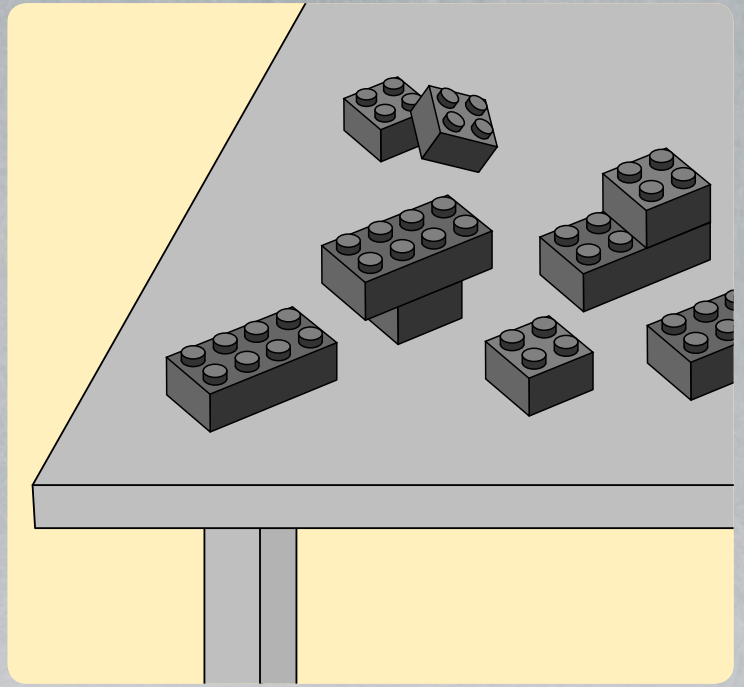
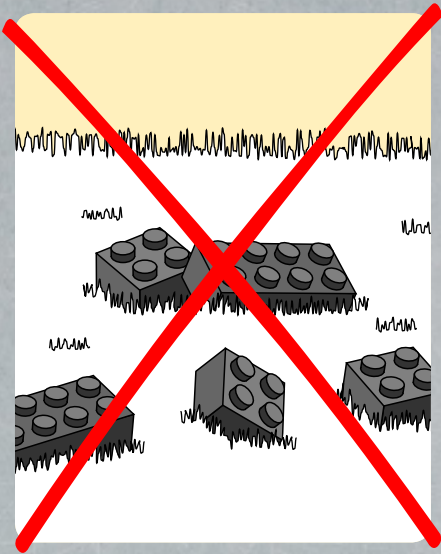

2





1

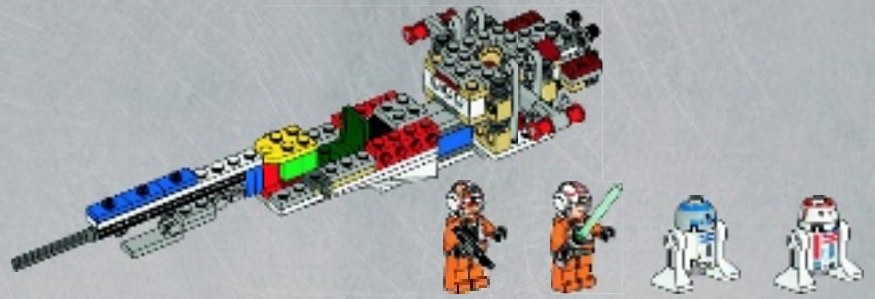
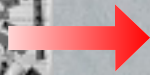

2

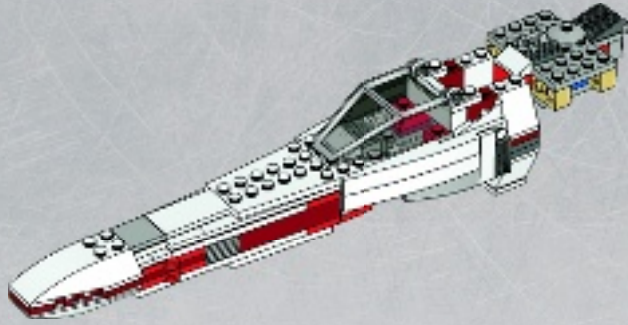

3

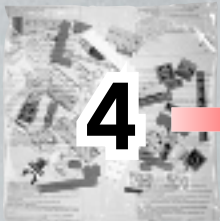

4



5



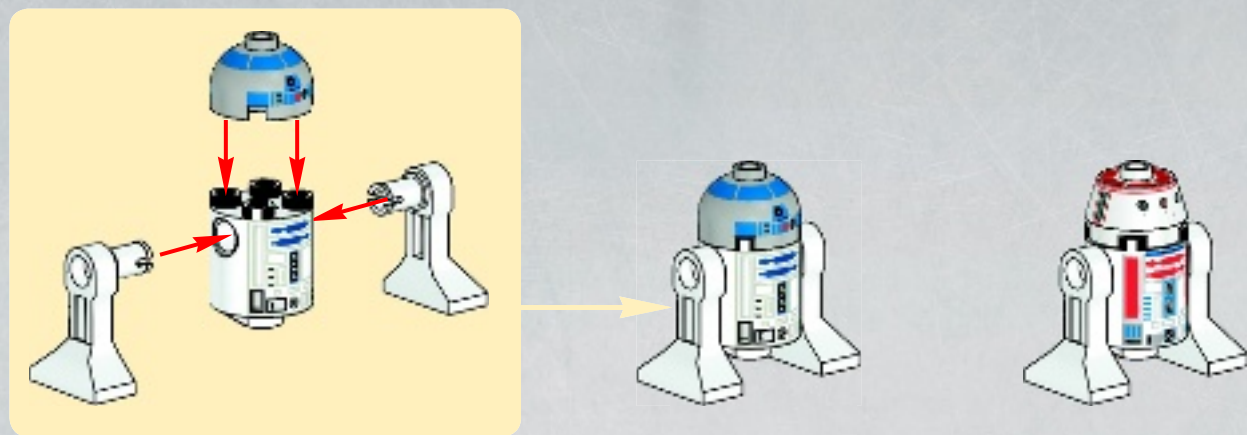
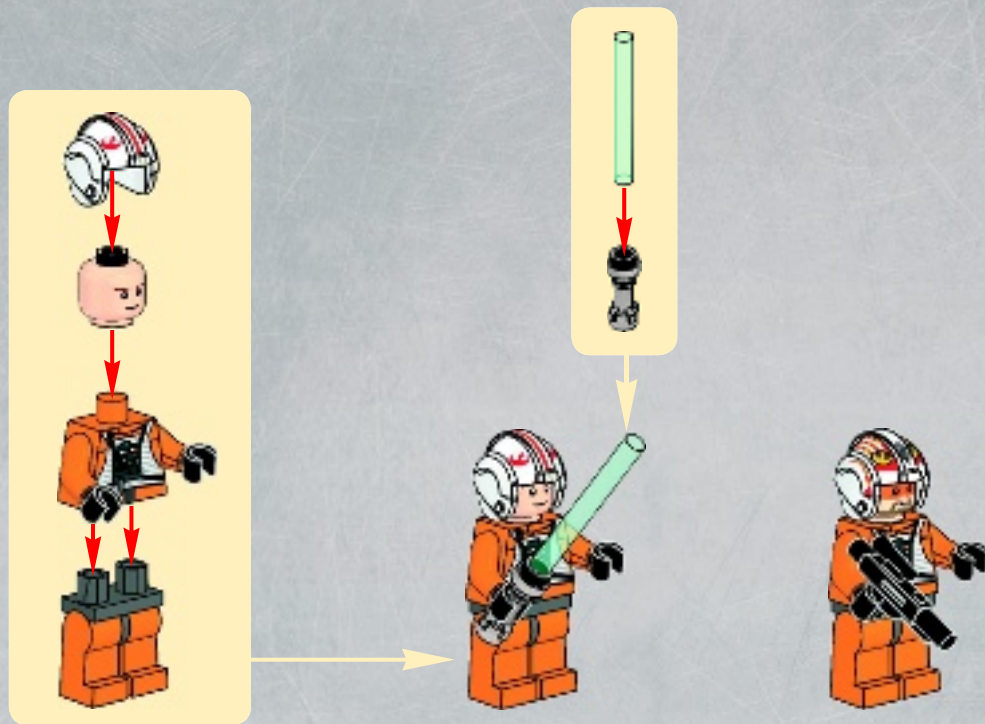
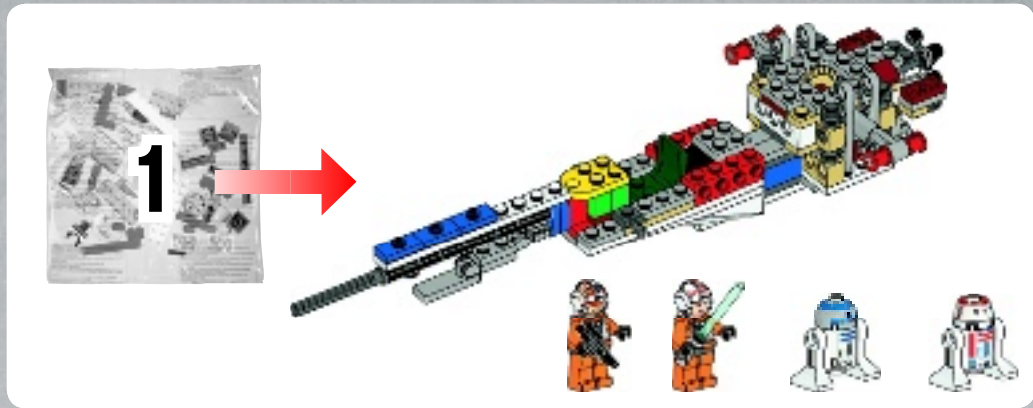

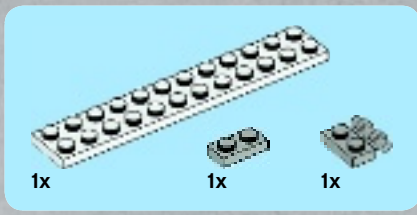

1

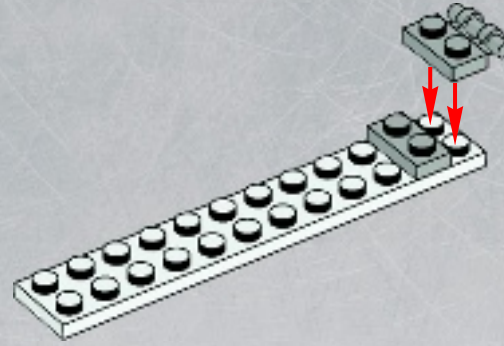

2

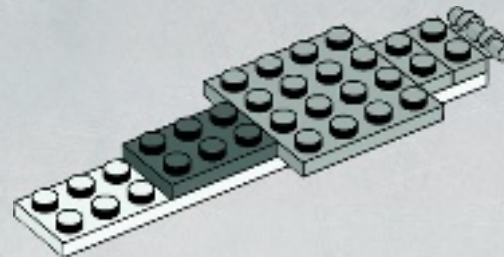

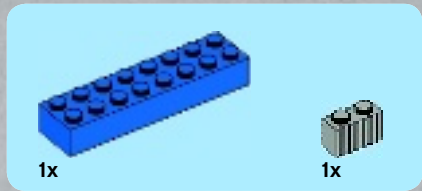

3

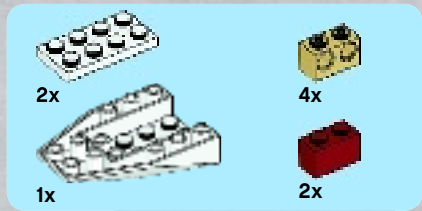
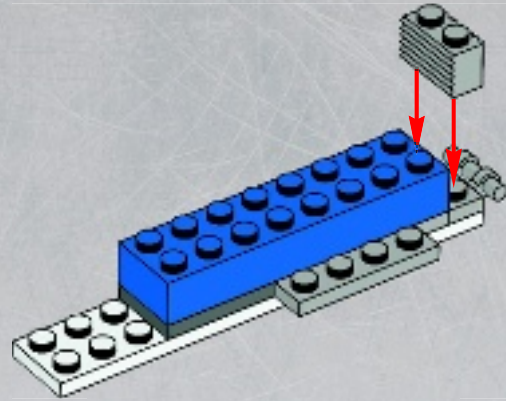

4

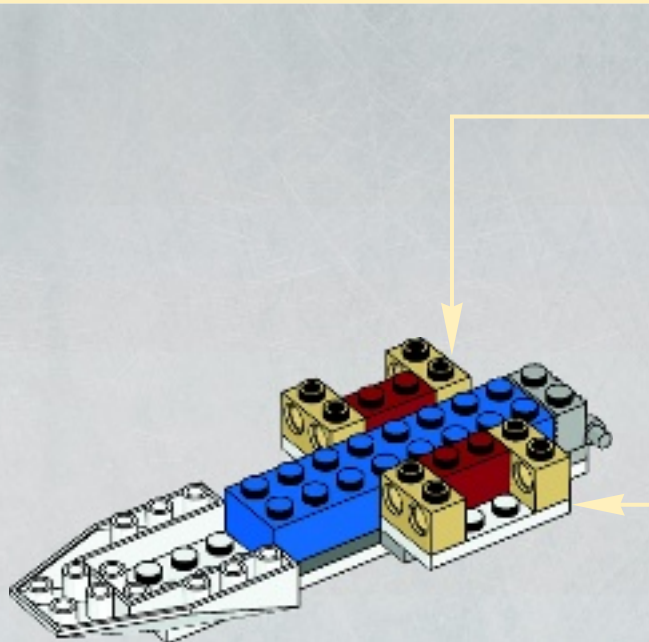

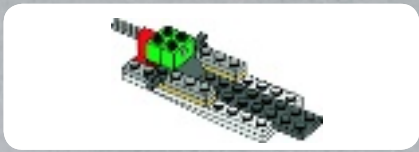

1

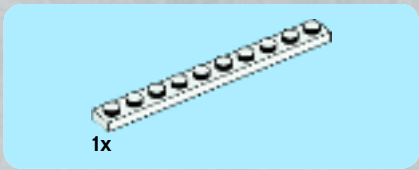
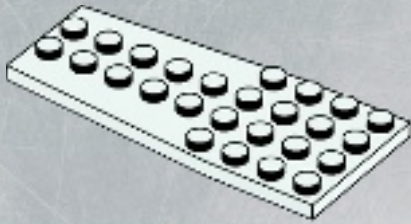

2

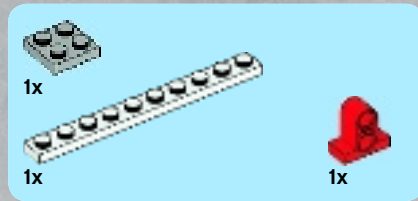
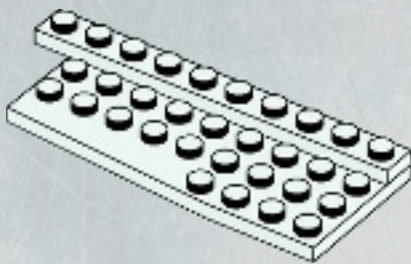

3

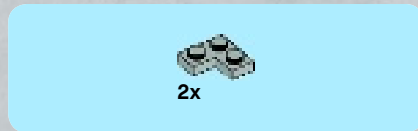
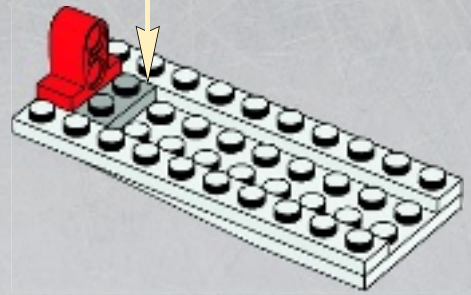
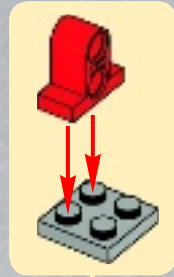

4

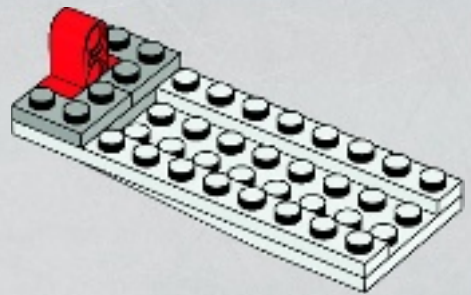



5

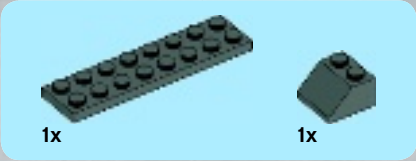
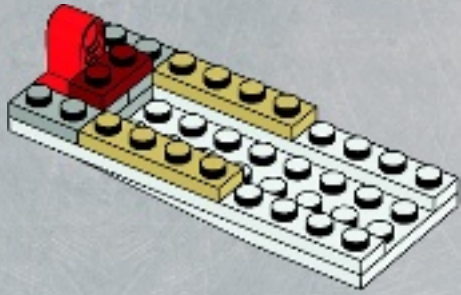

6

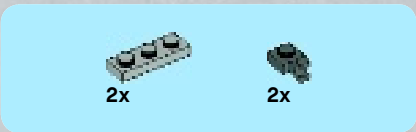
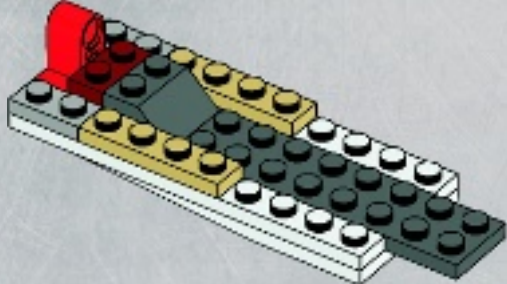

7

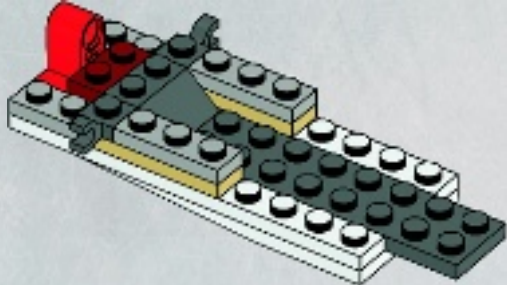

8

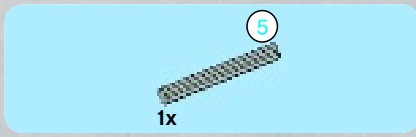
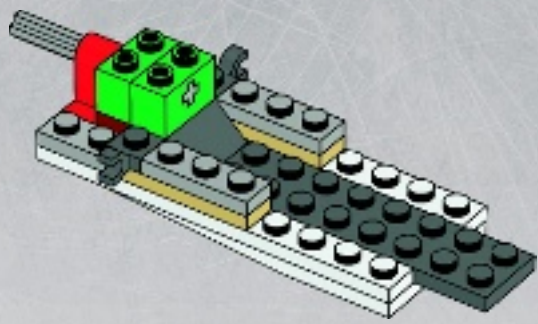

9

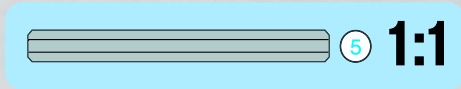
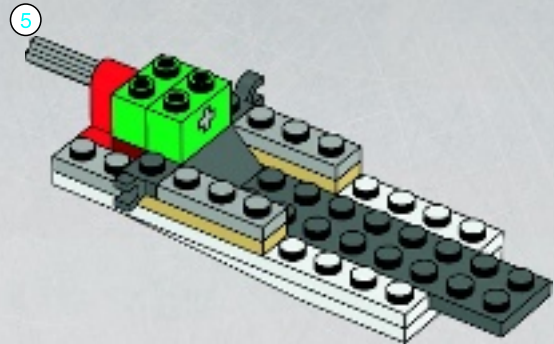

5

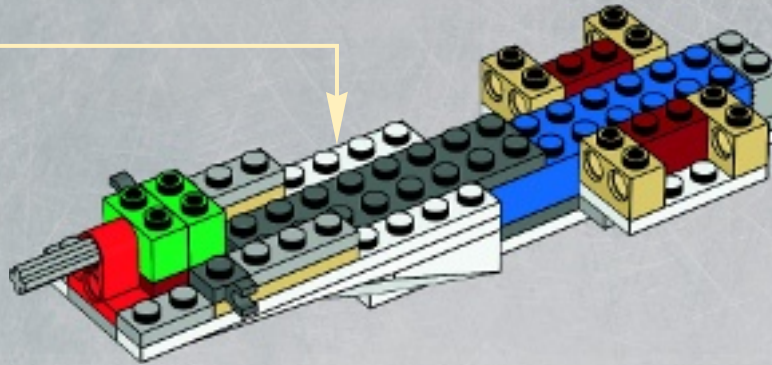

1x

6

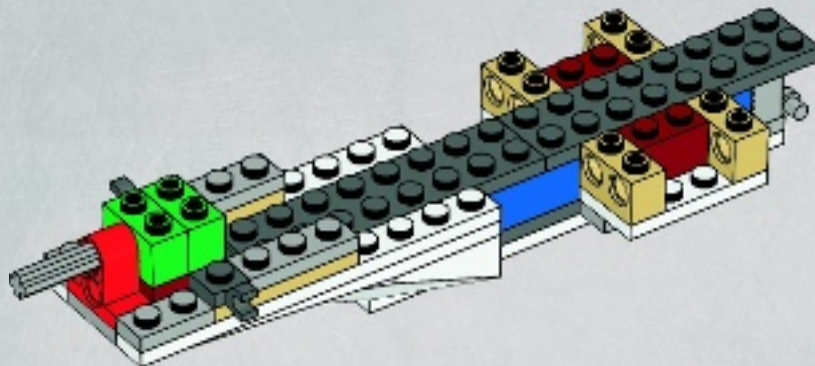

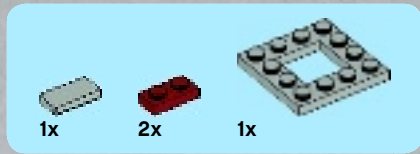

7

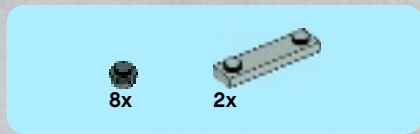
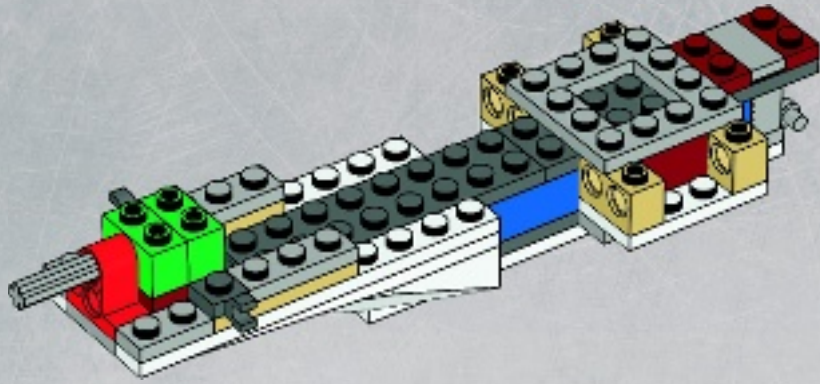

8

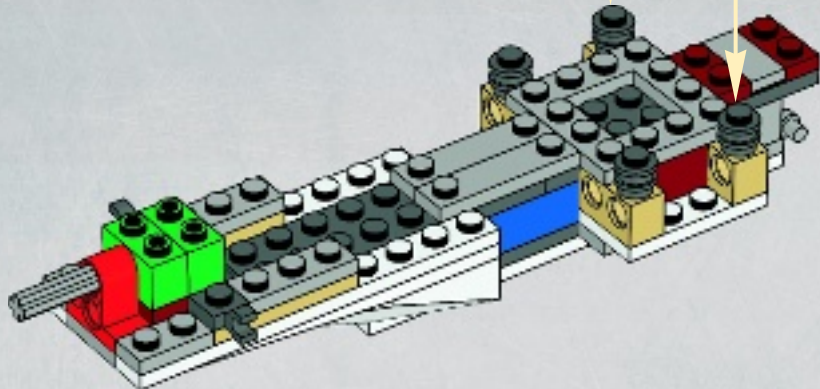
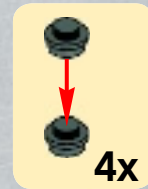

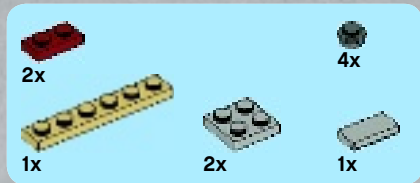

11

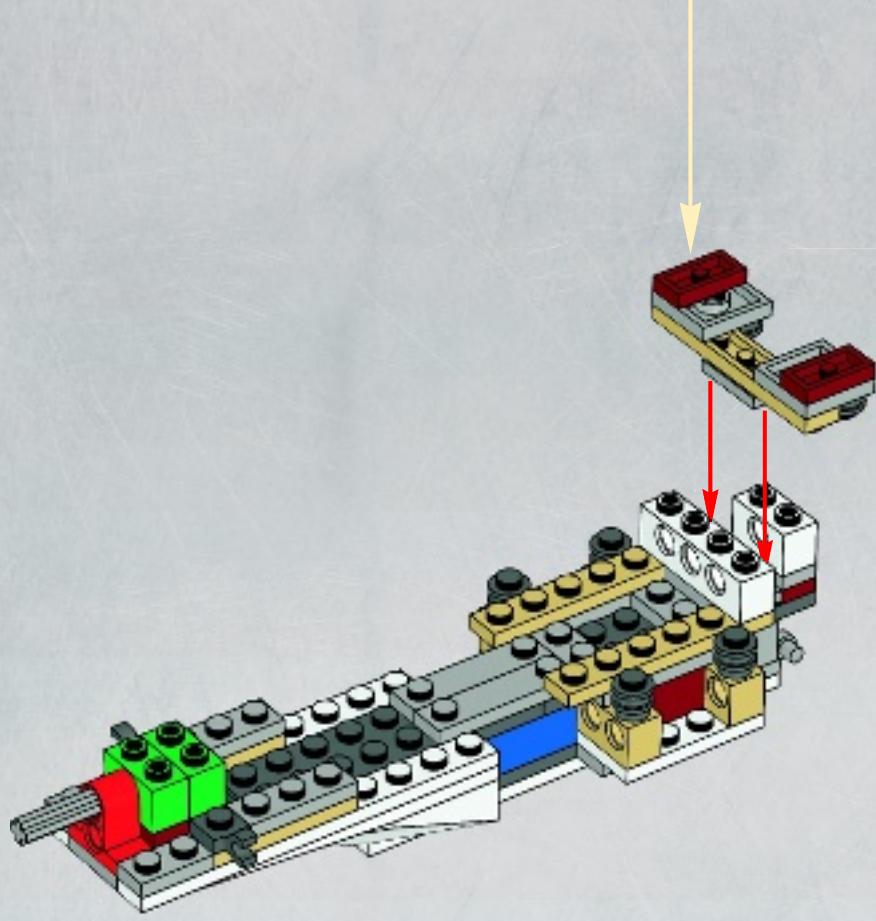
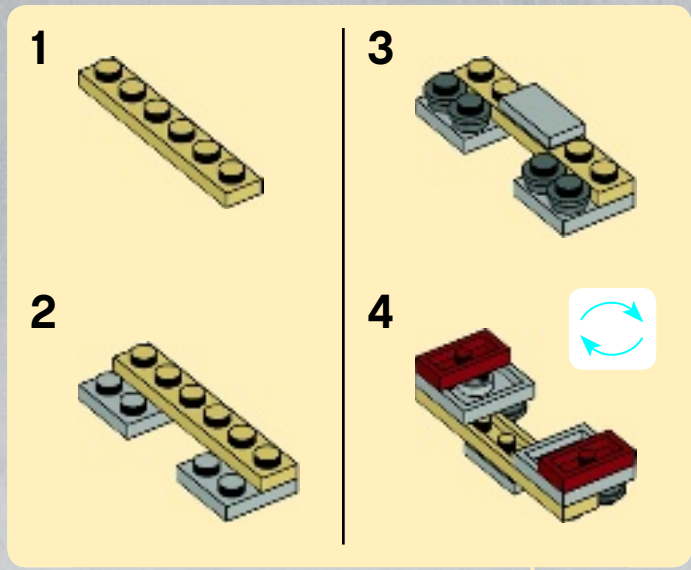



12

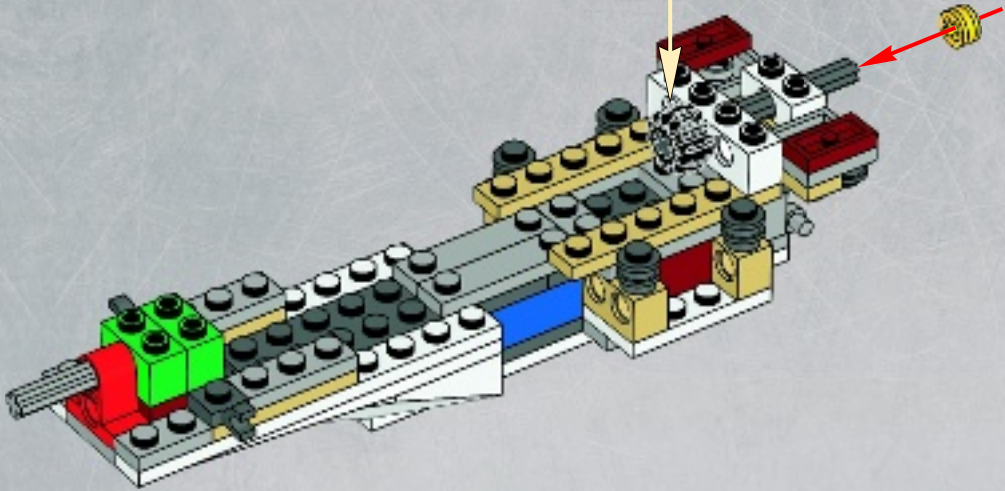
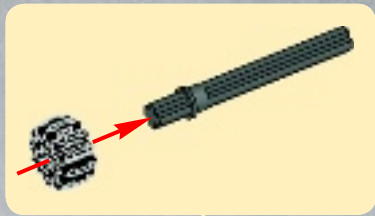

13

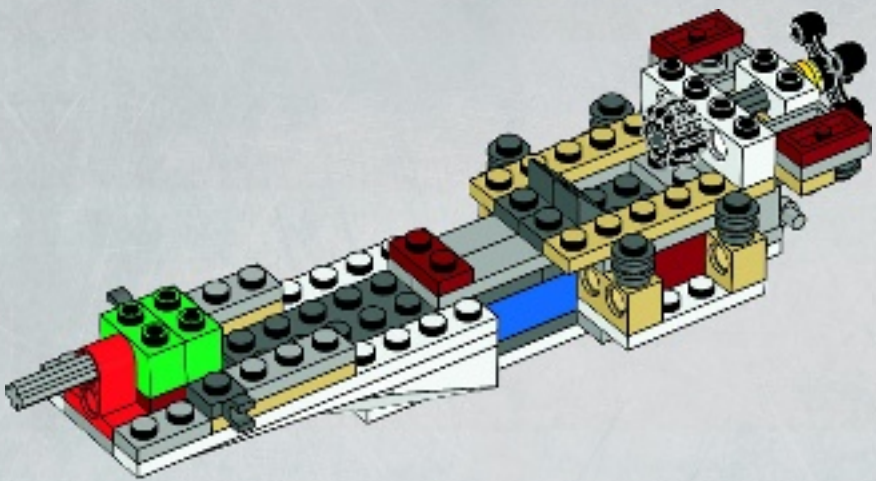

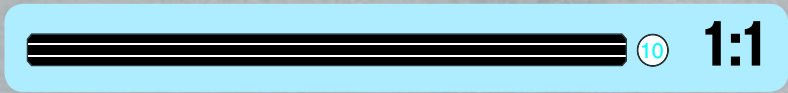
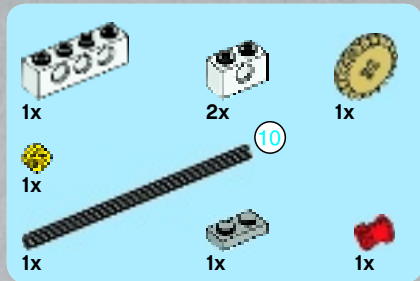

14

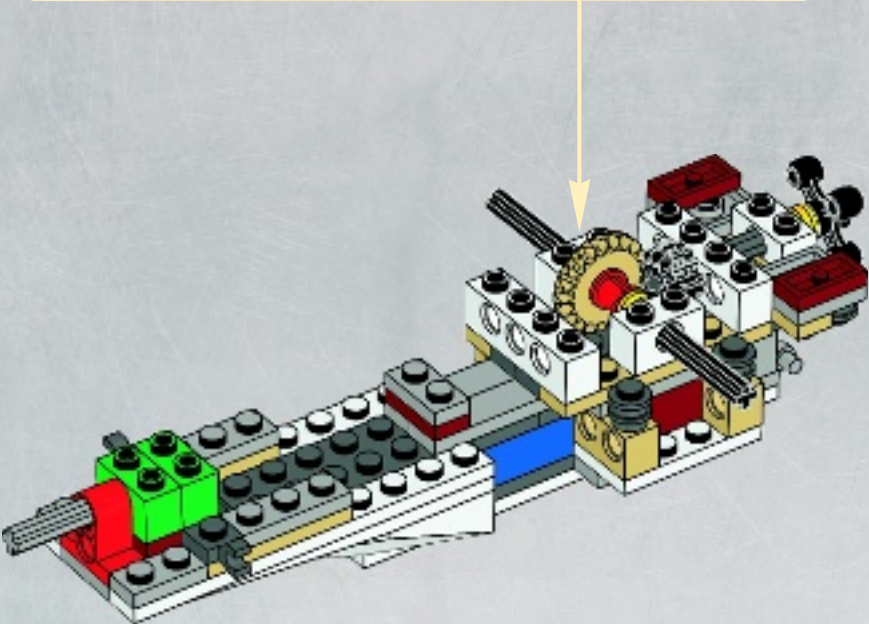
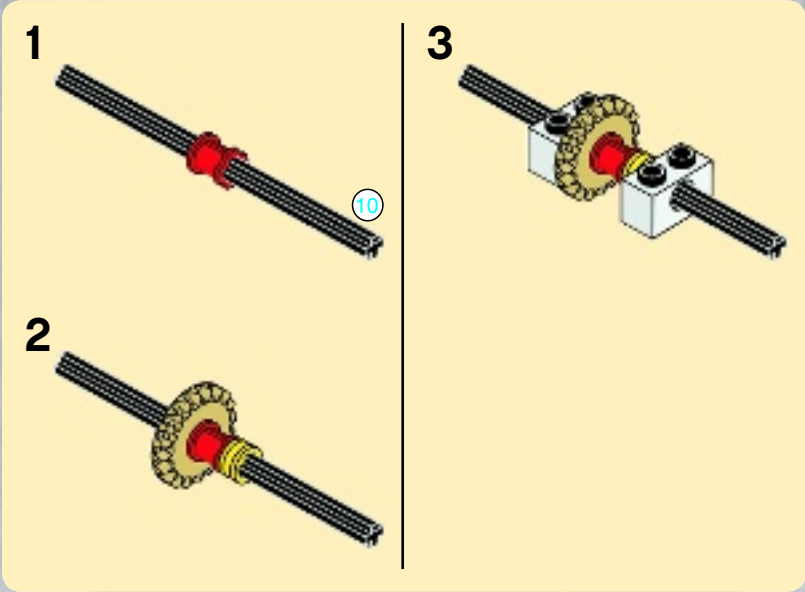



15

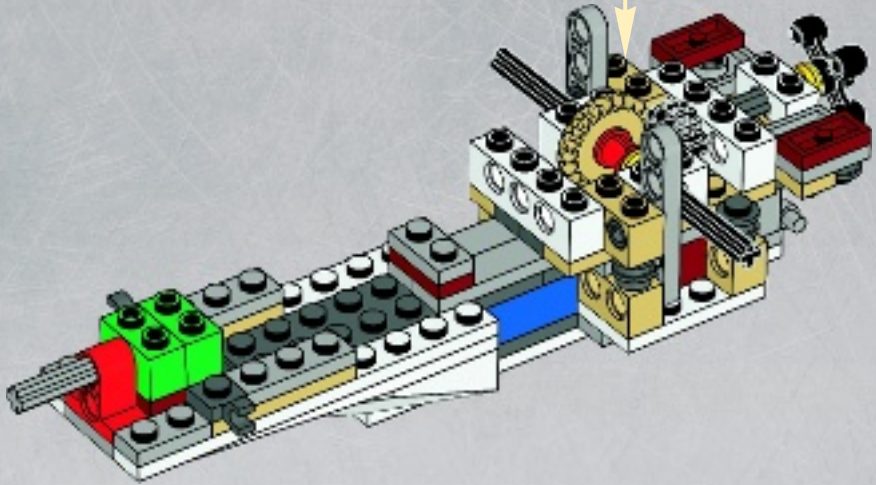

16

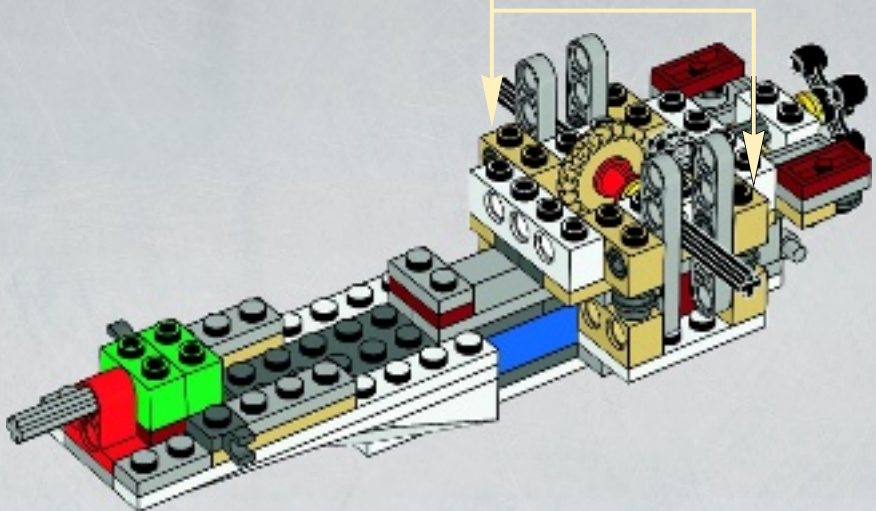
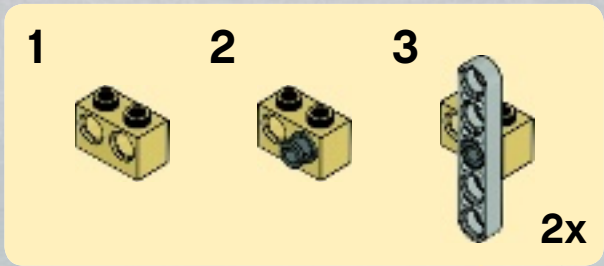



2x

17

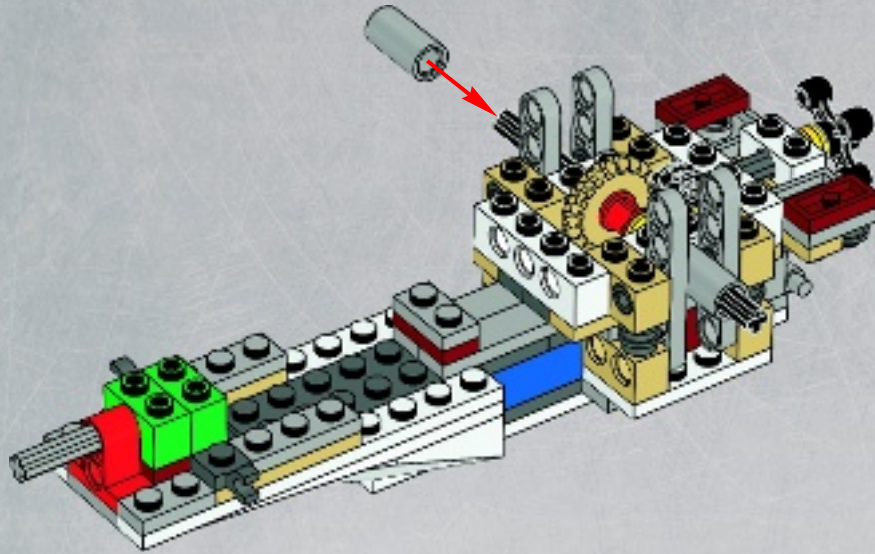

2x



2x



4x

18

1

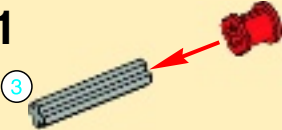

3

2

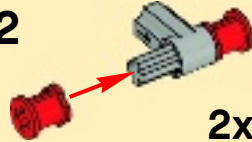

2x

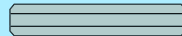
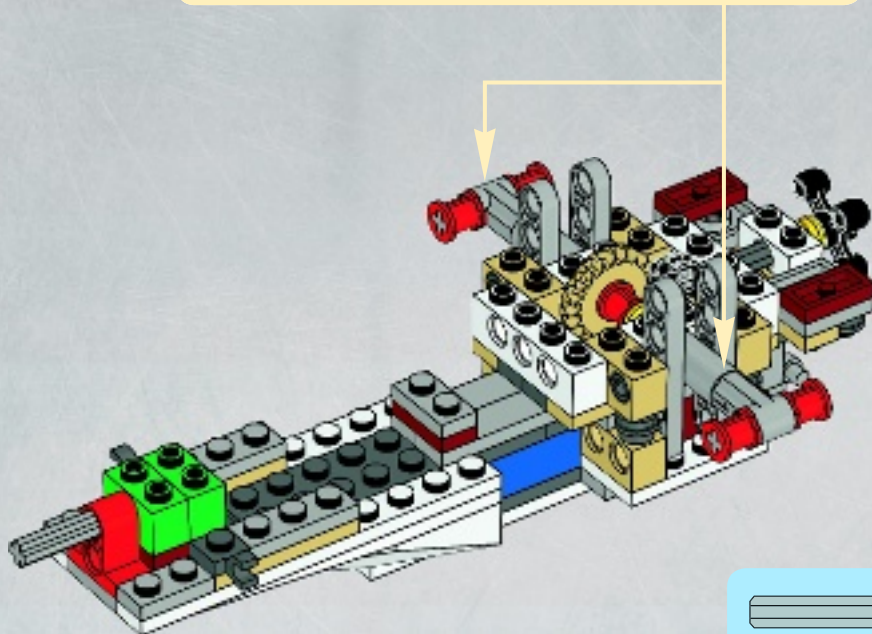

3

1:1

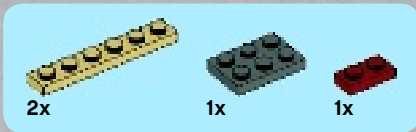

19

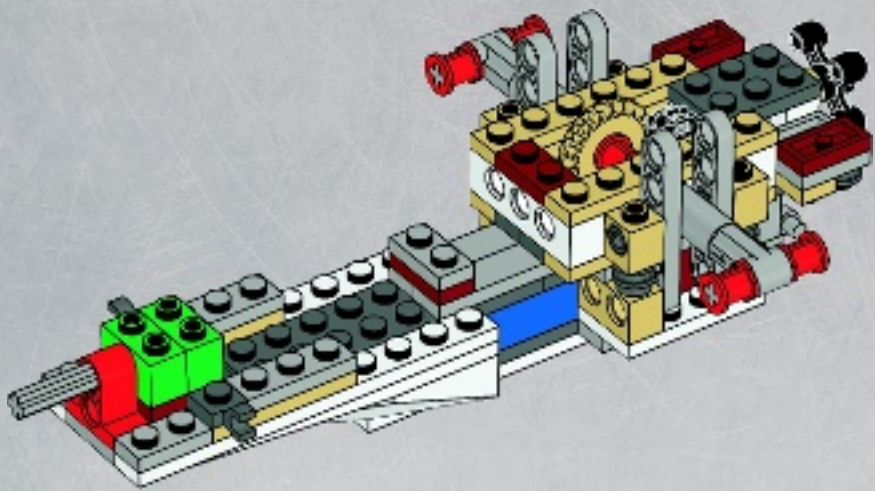

20

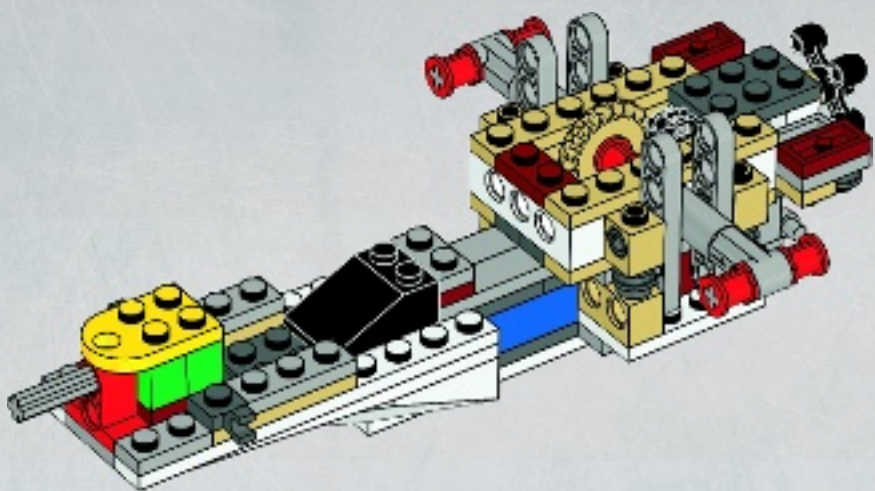





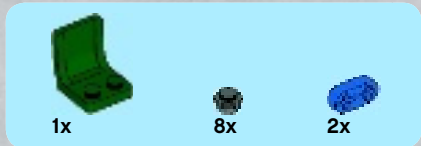
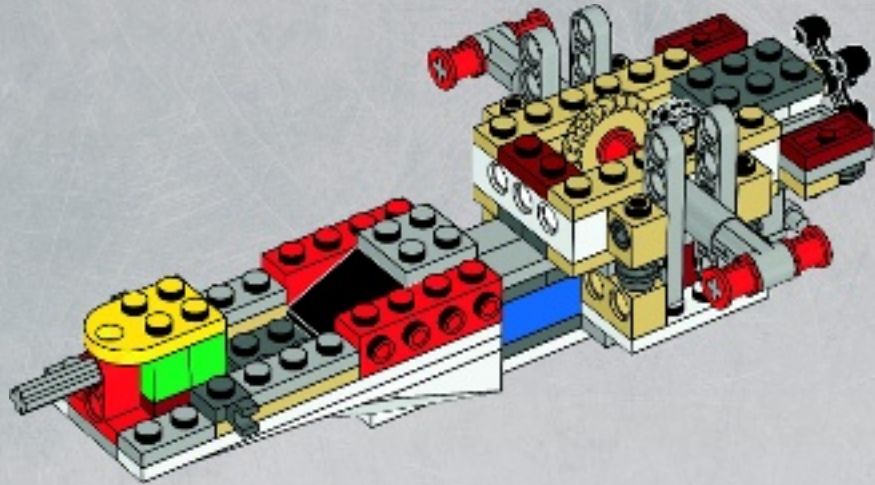

21

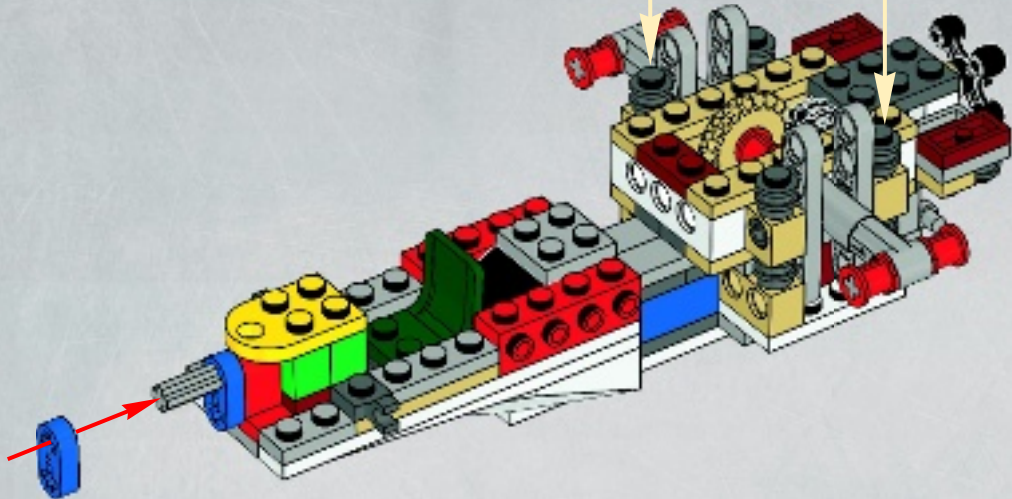
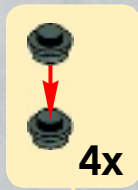

22



1x  2x 
 1x  1x 

 ③ 1:1

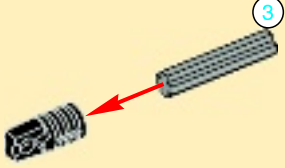

23

1  ③

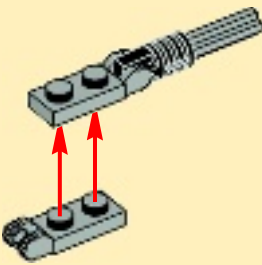
2 

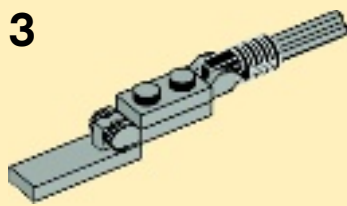
3 

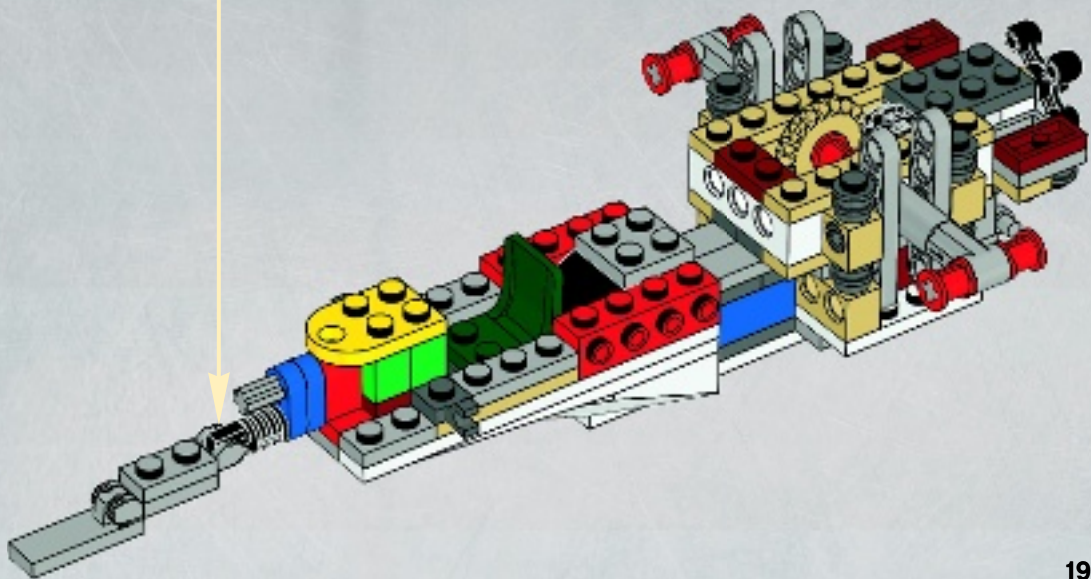

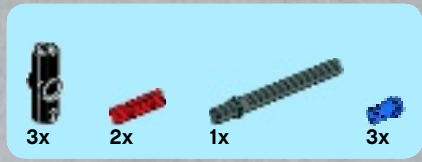

24



3



4

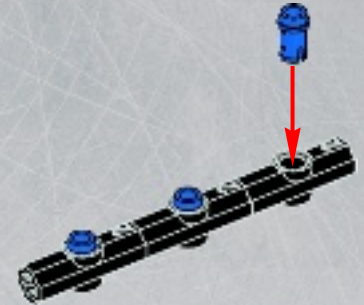

5

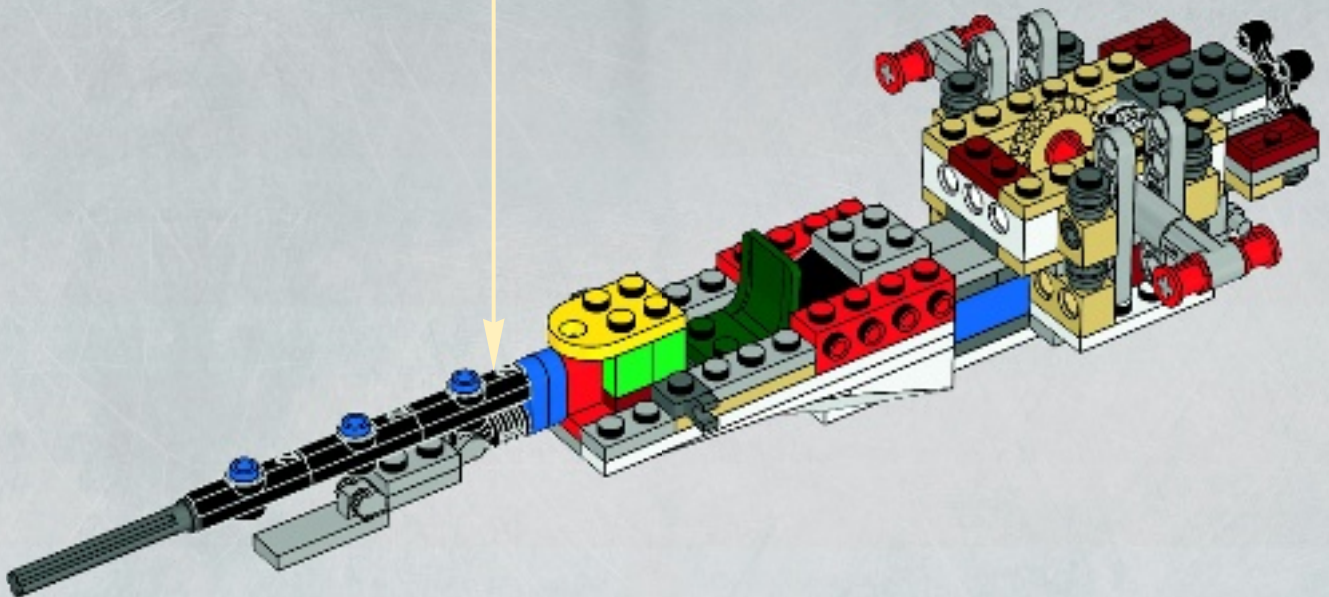
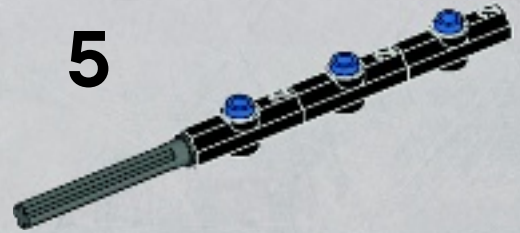

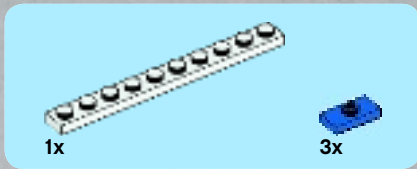

25

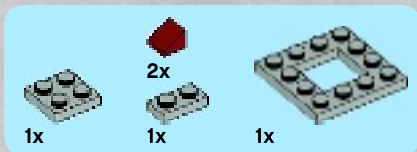
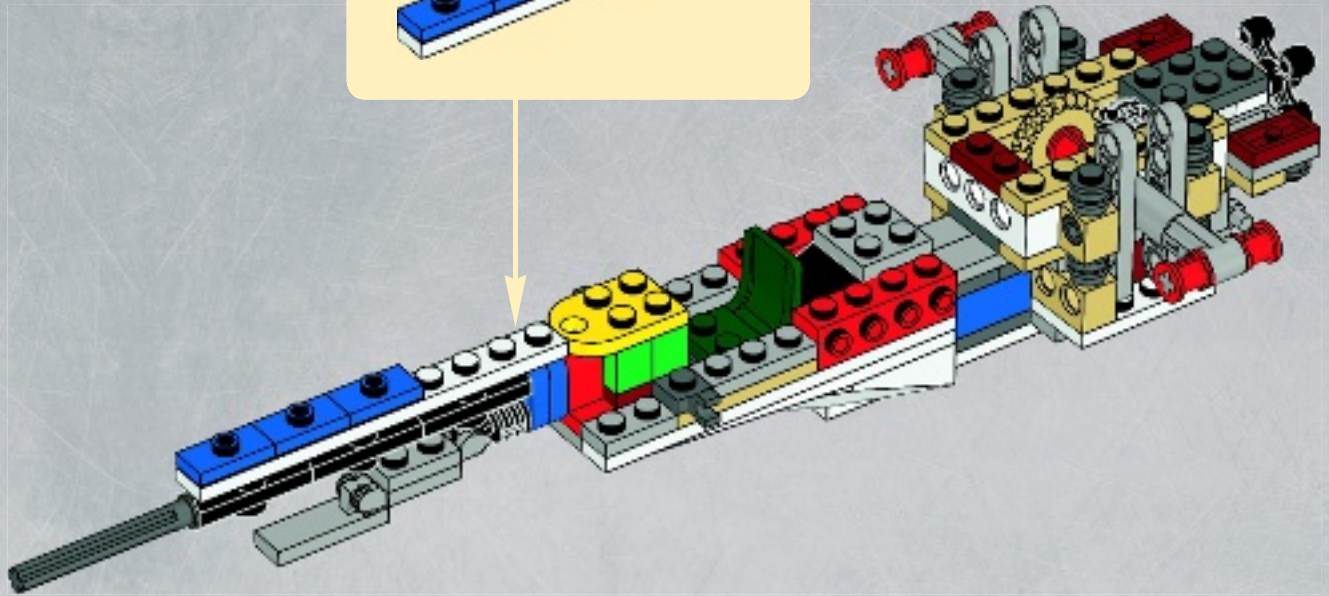
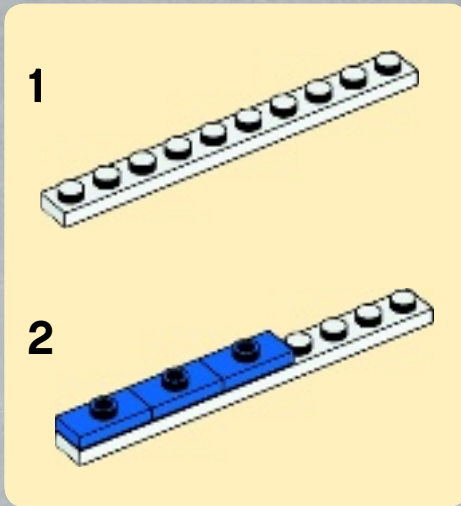

26

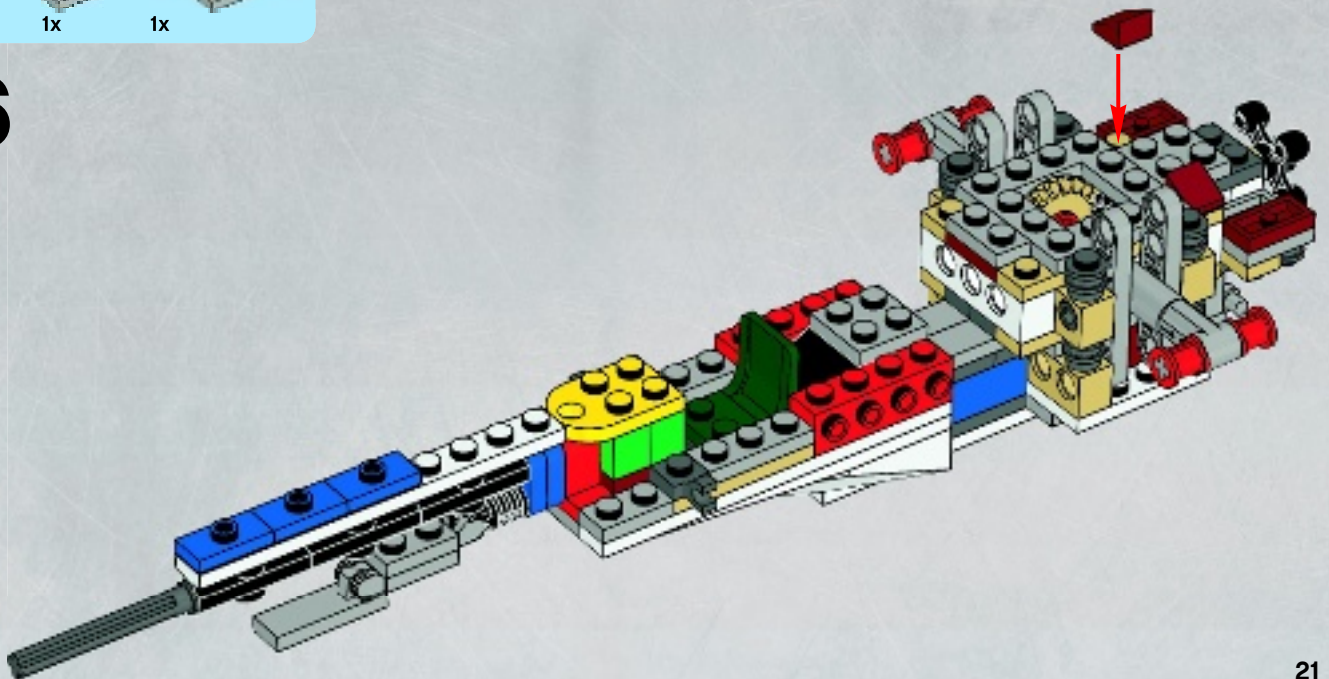



2

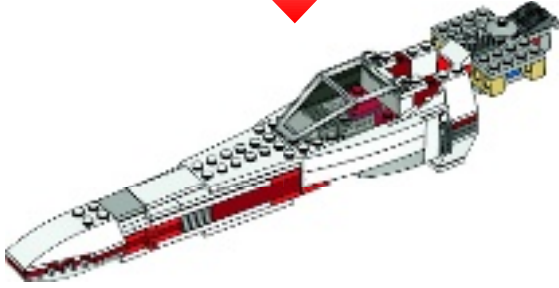

1x

1

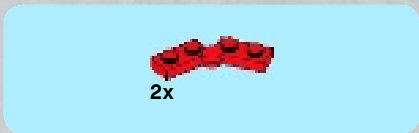

2x

2

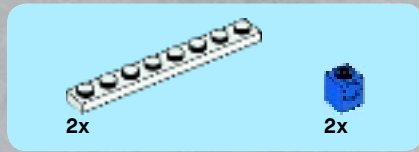
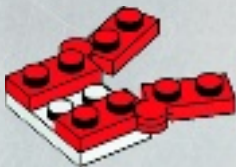

2x

2x

3

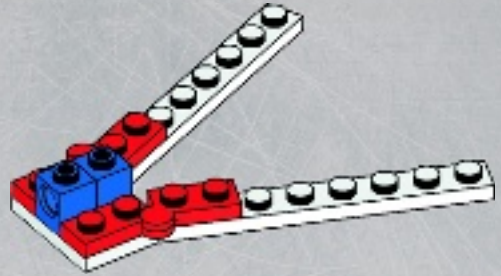

4x

4

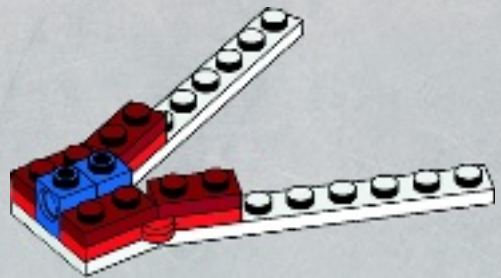

2x

2x

5

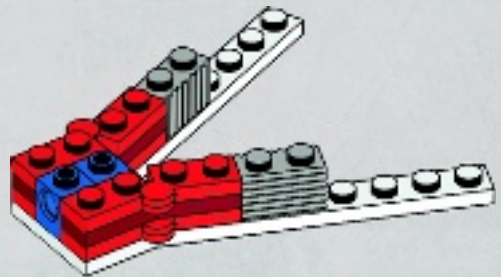



2x

6

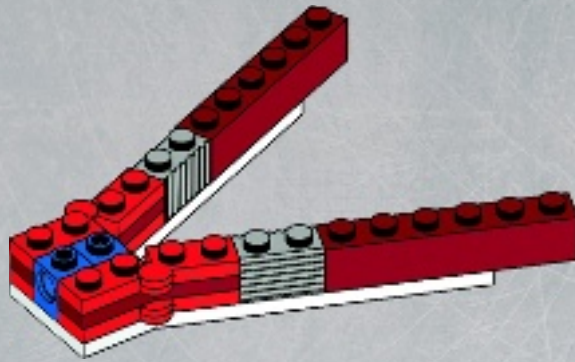

2x

7



2x

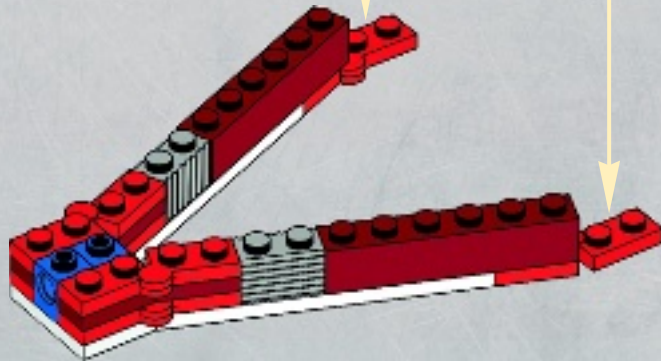

2x



2x

8

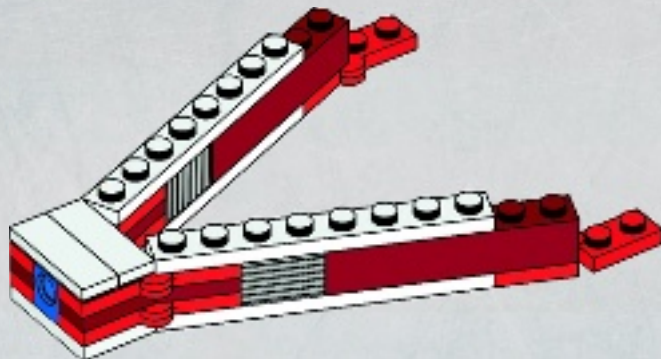

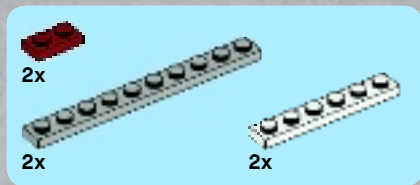

9

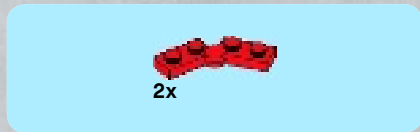
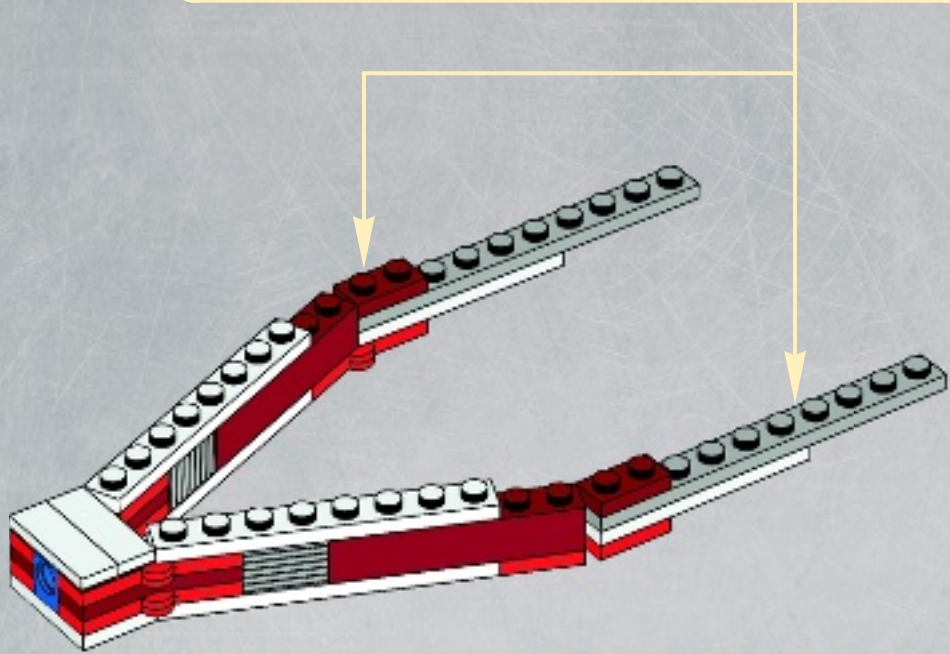
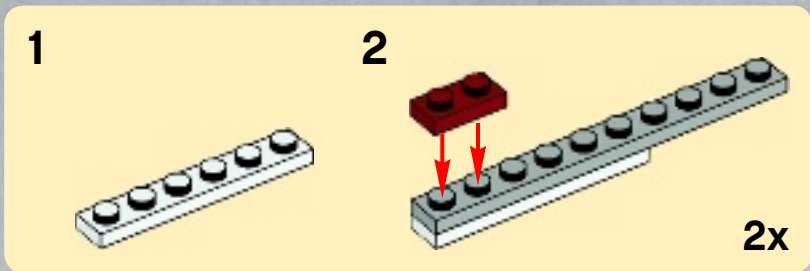

10

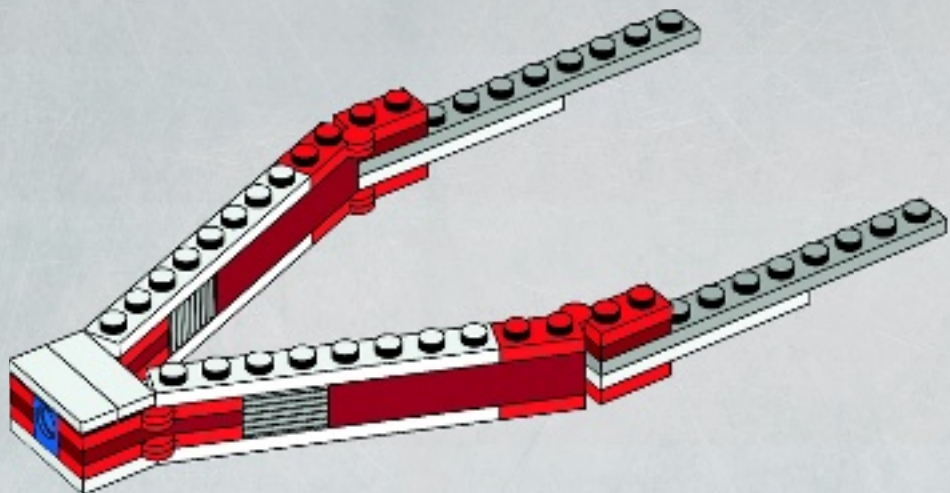

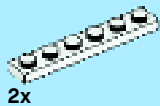

2x

11

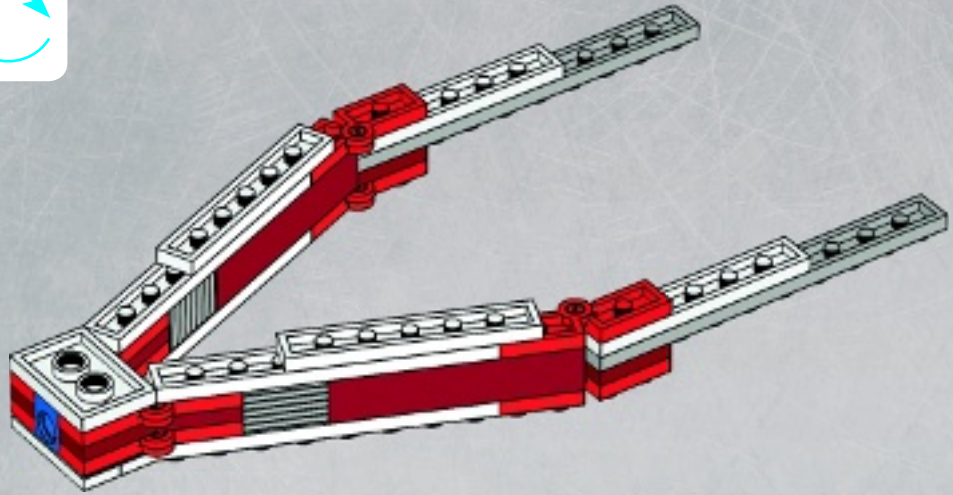

2x



2x

12

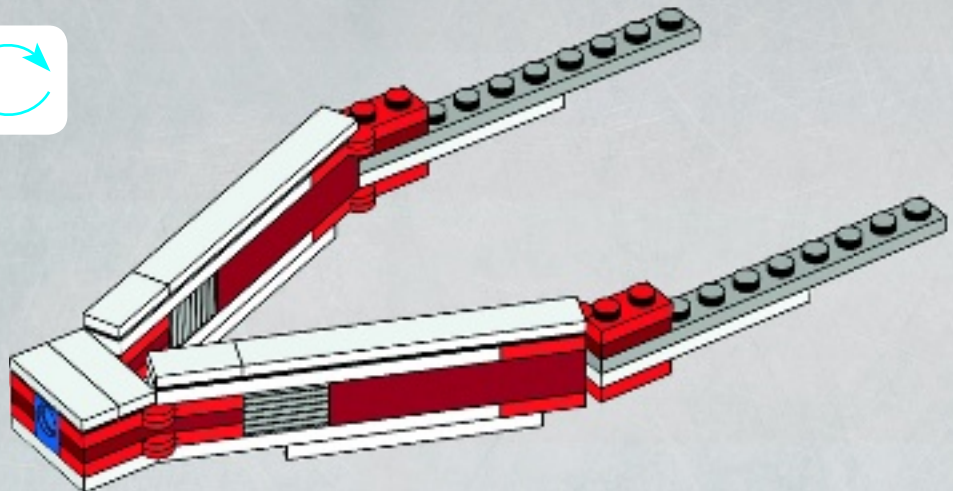

13

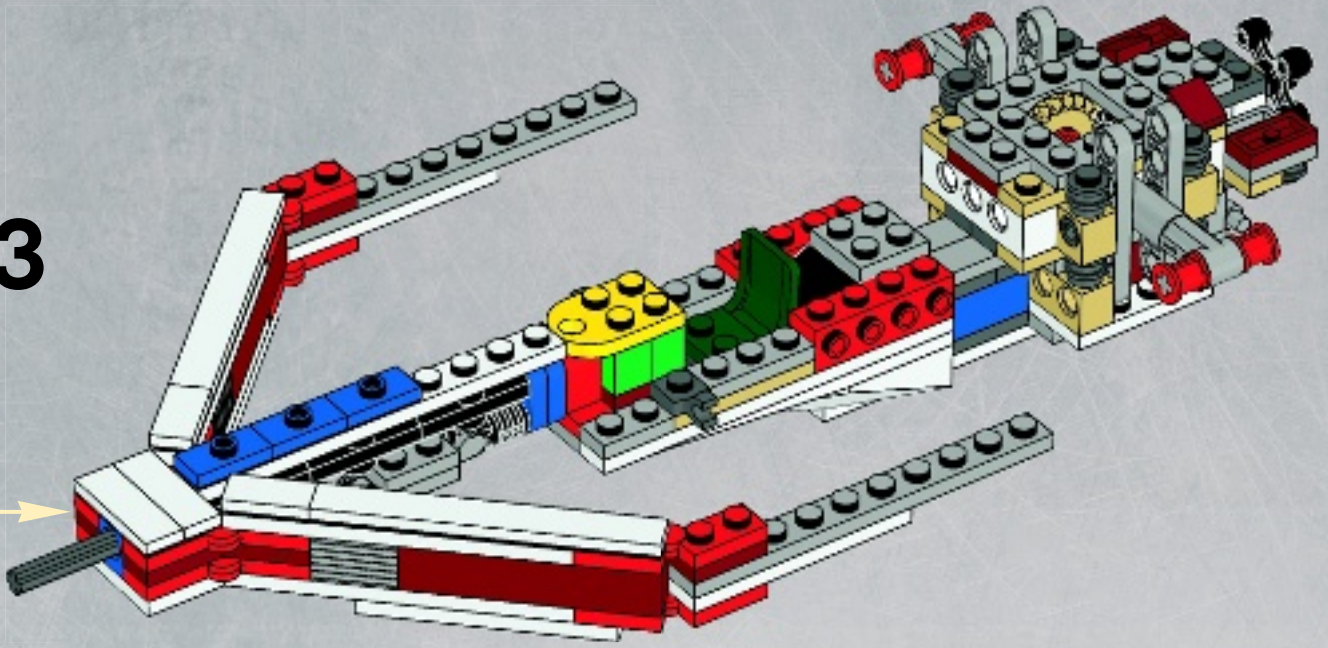

14

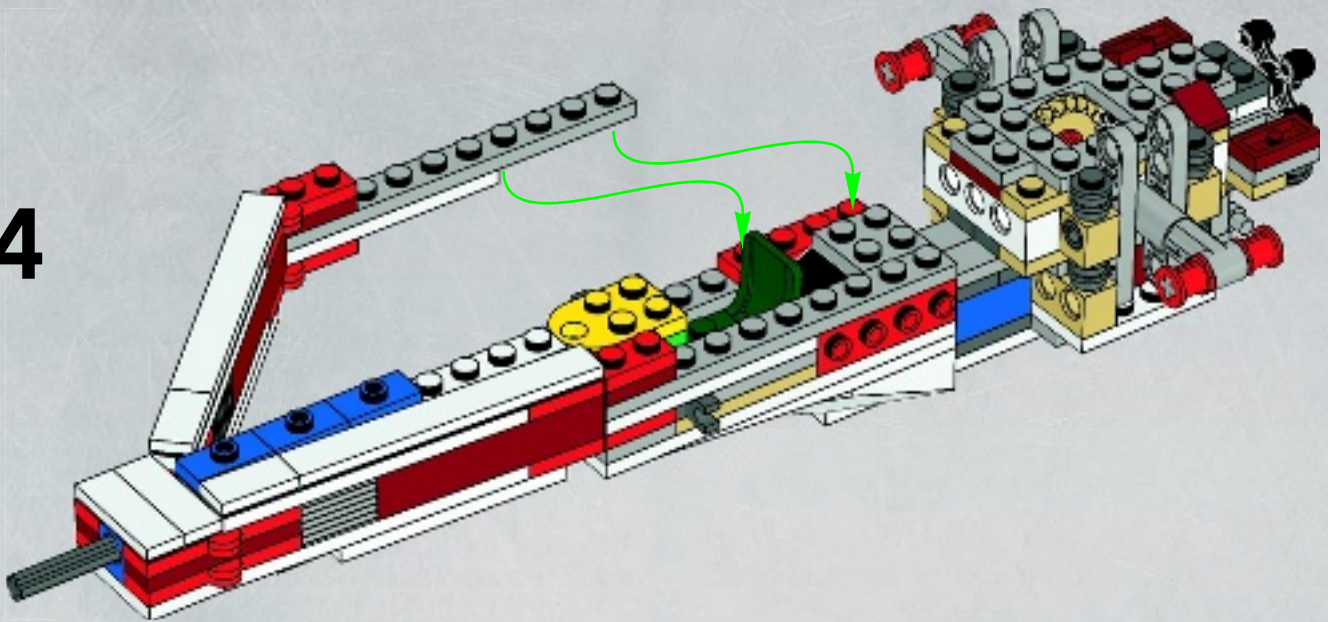

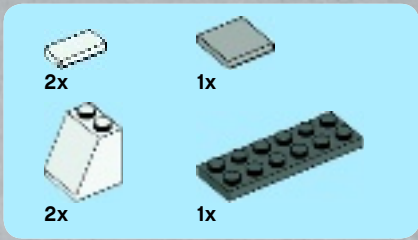

15

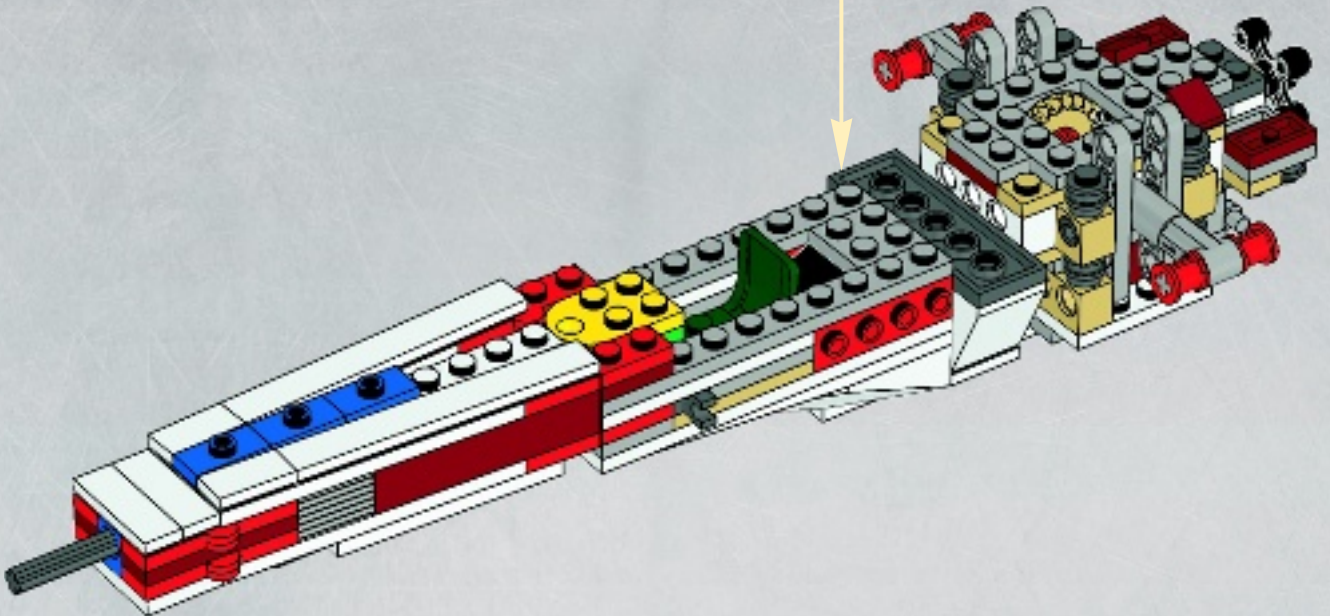
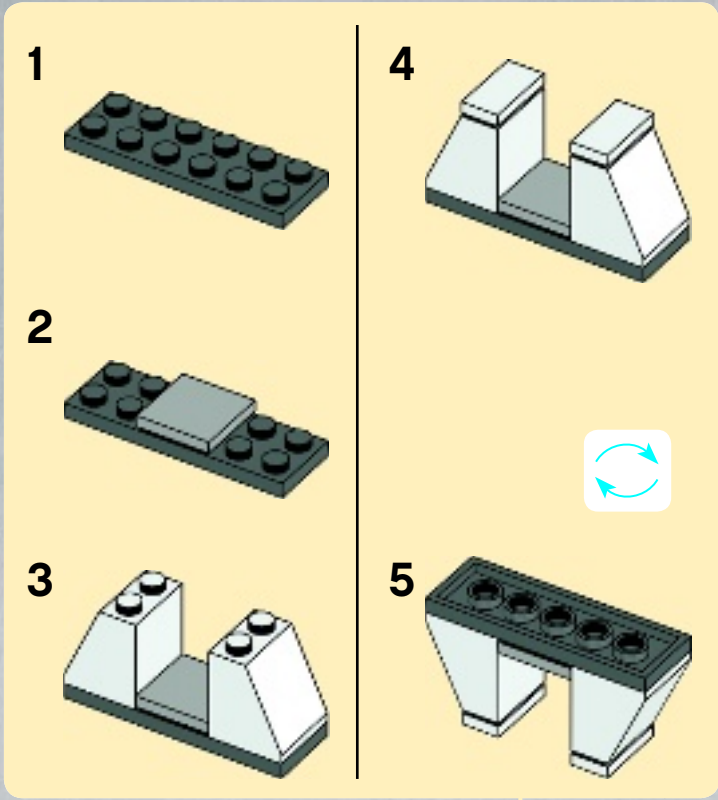

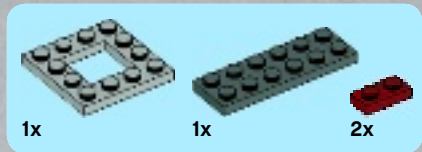

16

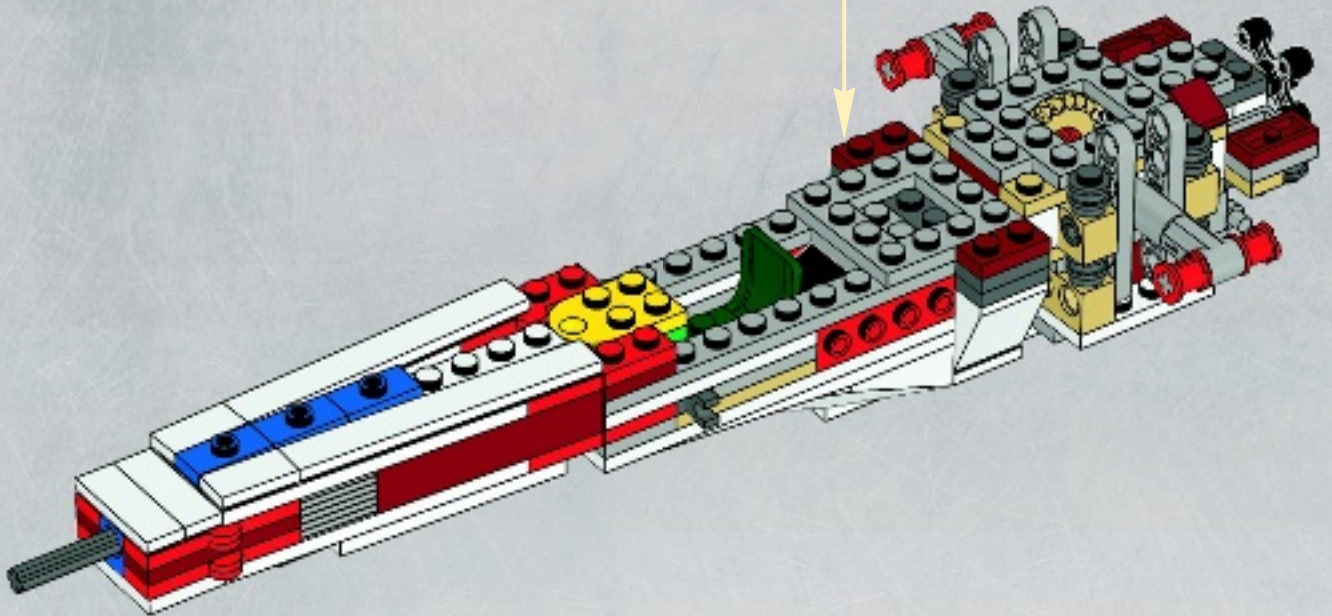
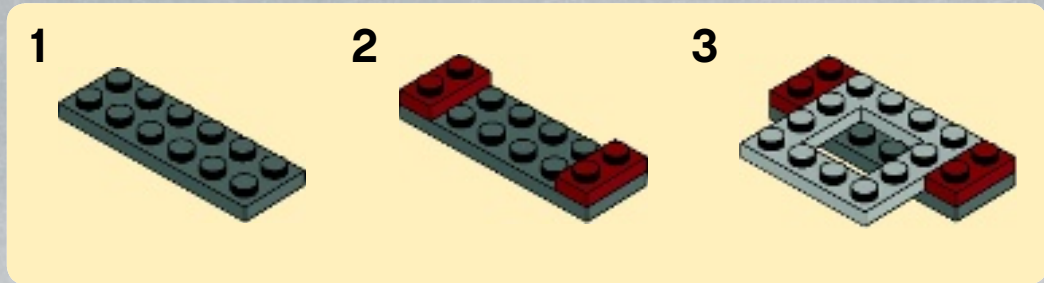



2x



2x

17

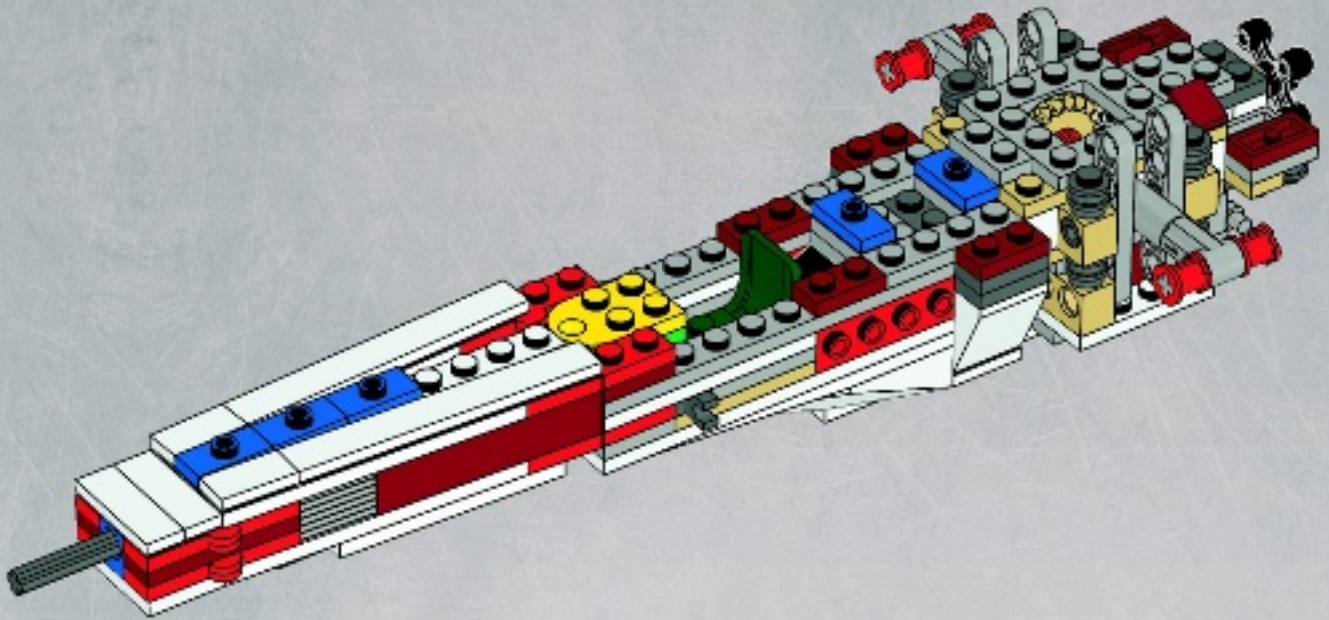

1x



1x



2x

18

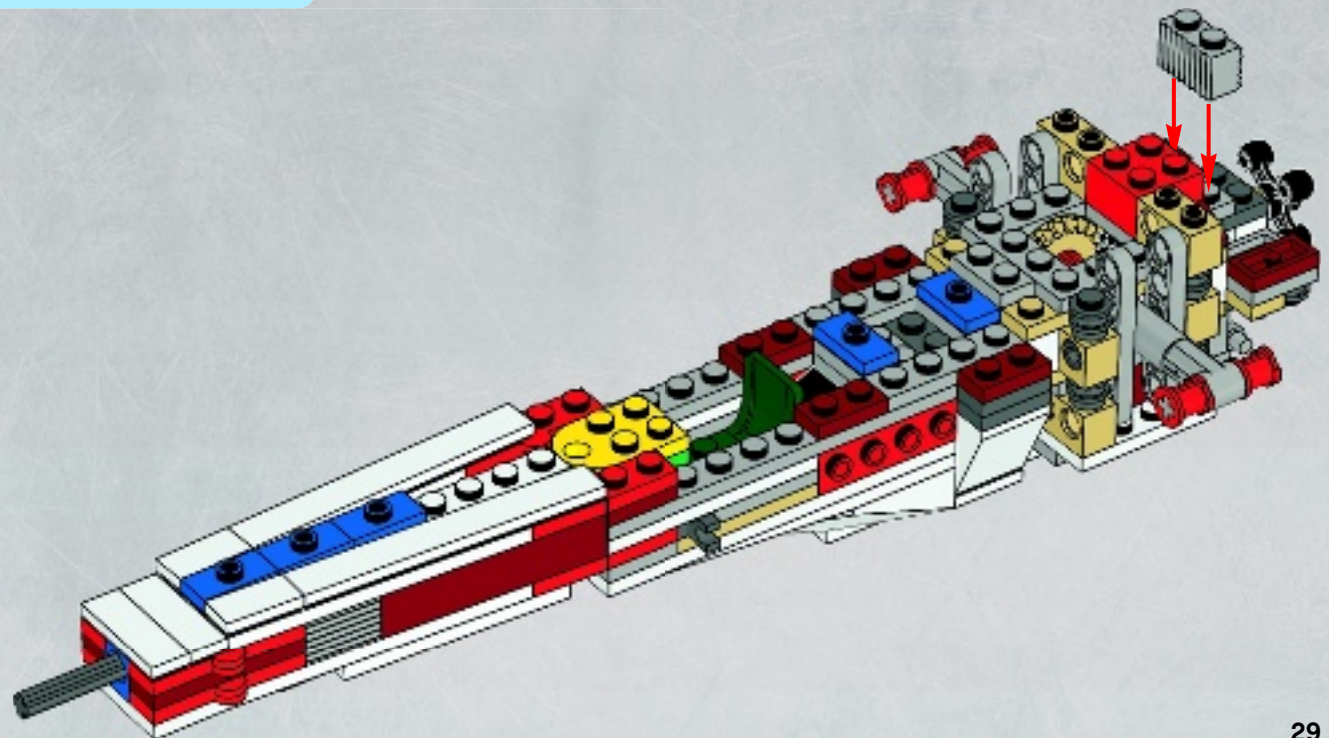



1x



1x



2x

19

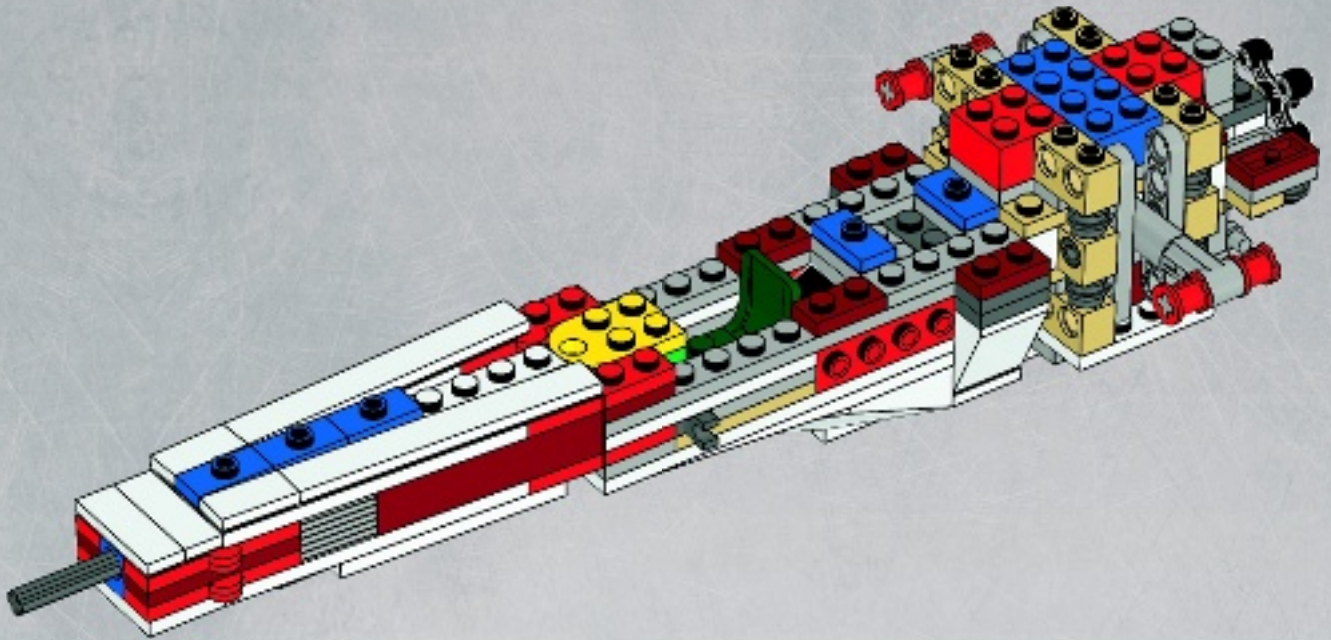

2x



2x



2x

20

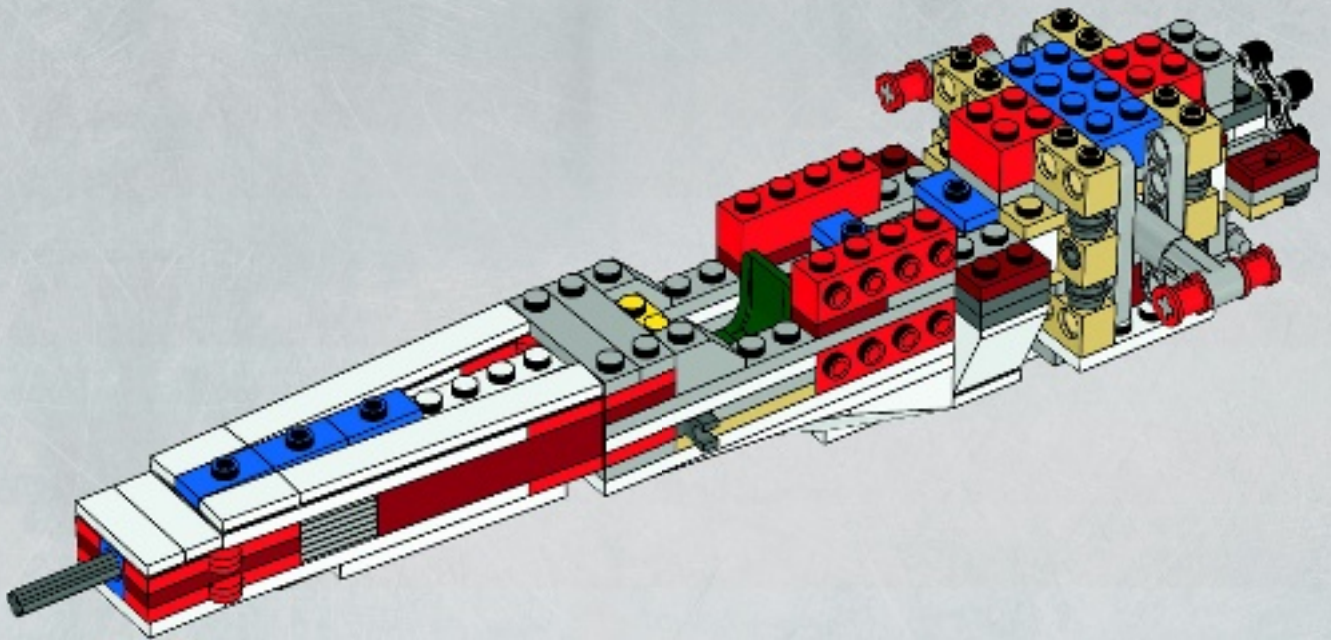

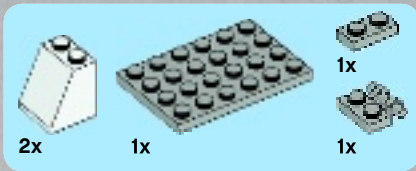

21

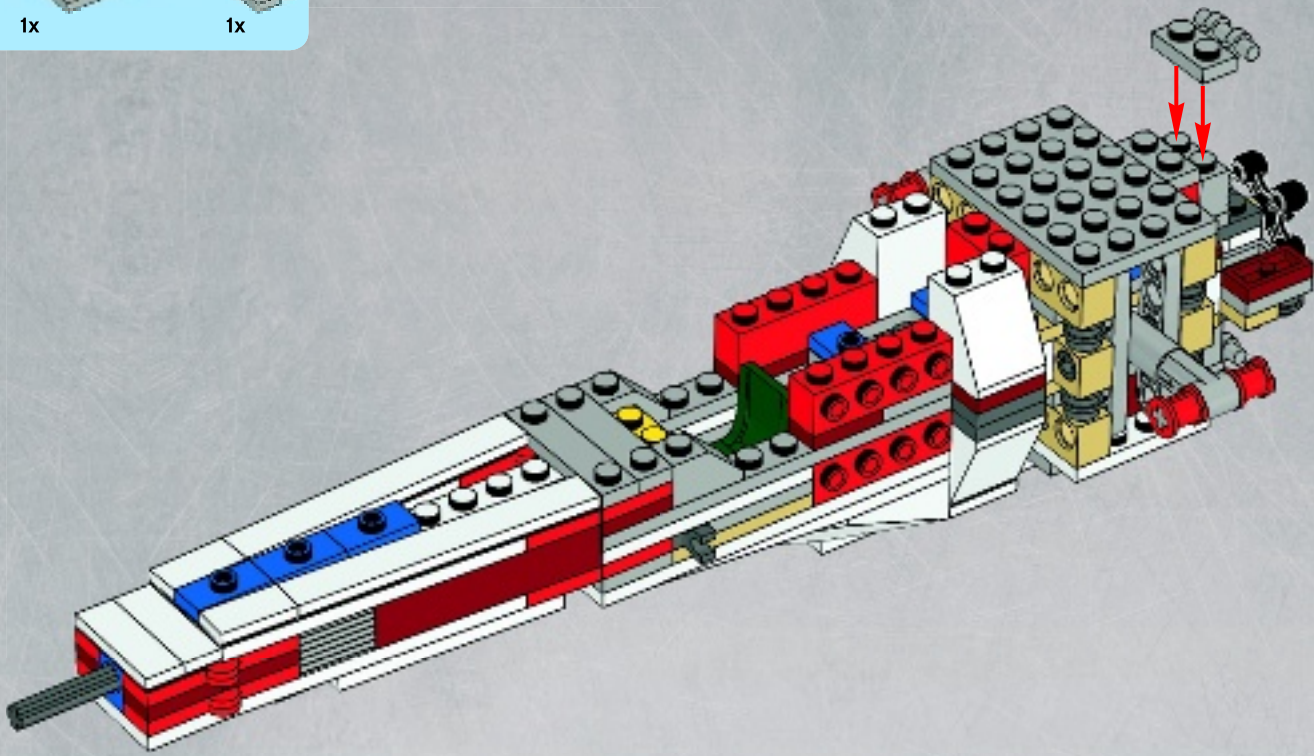

22

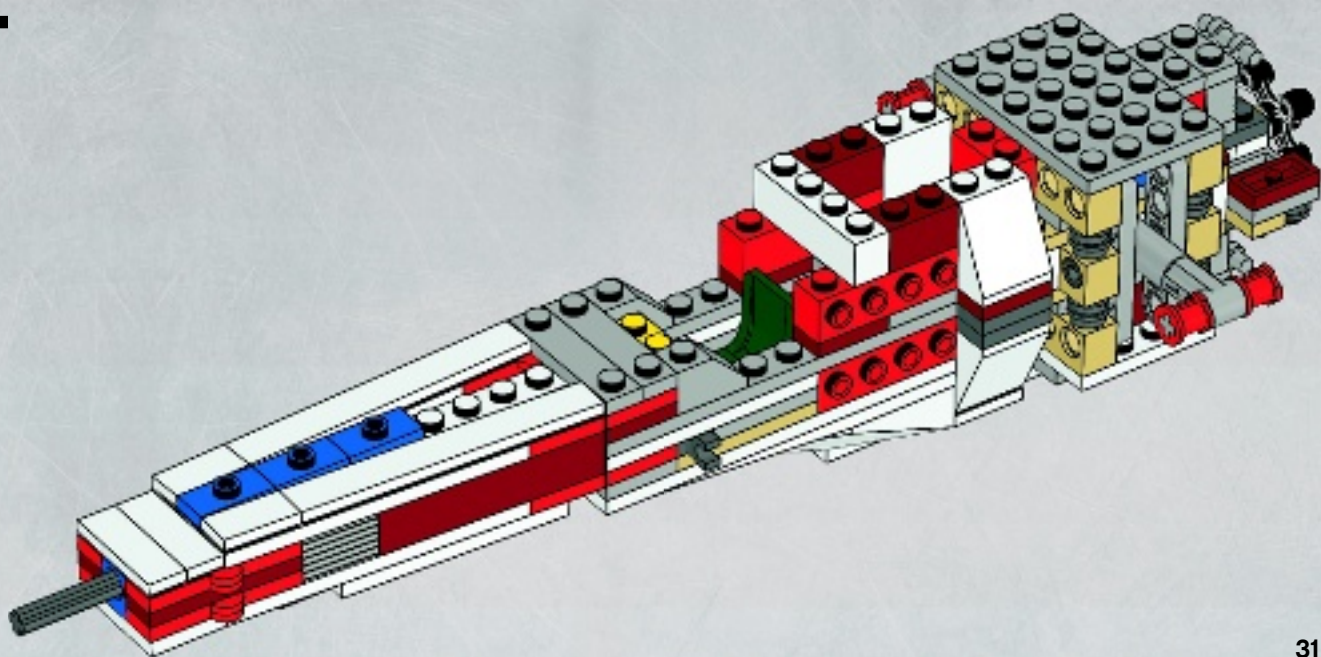

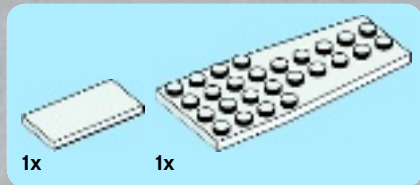

23

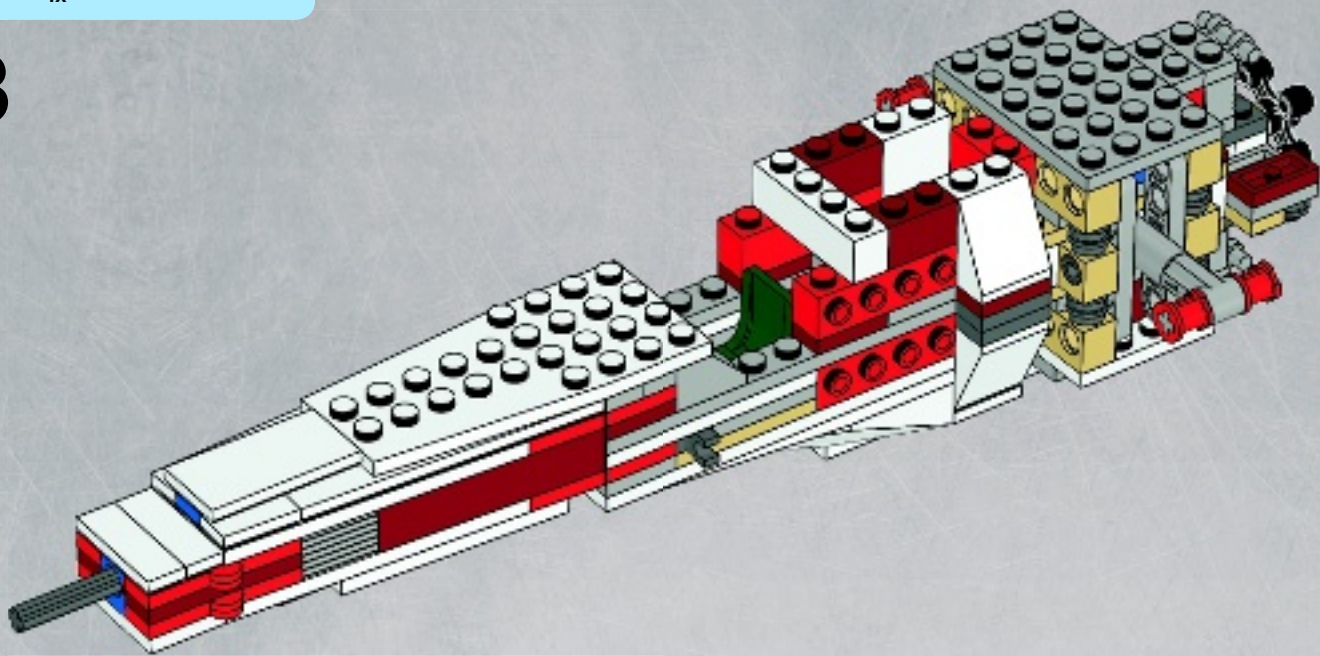

24

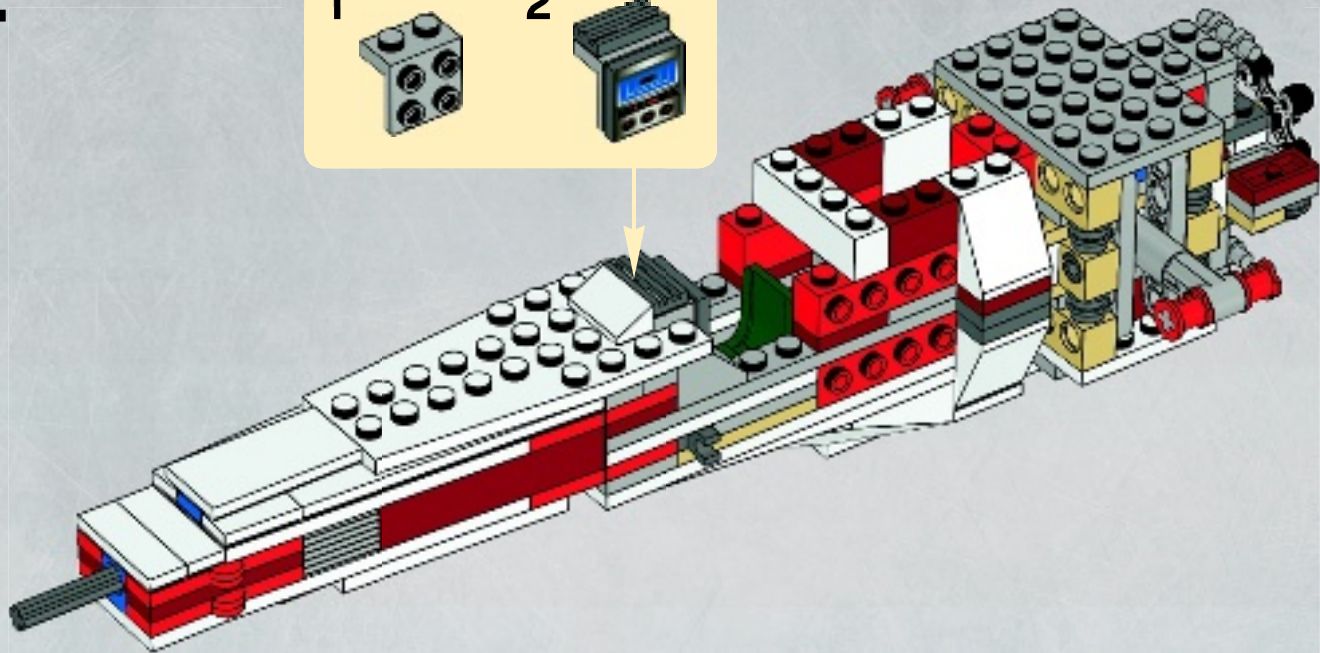
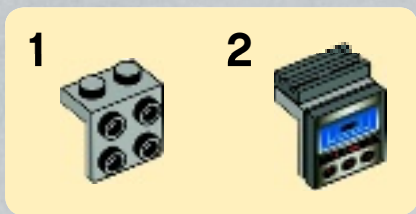



25

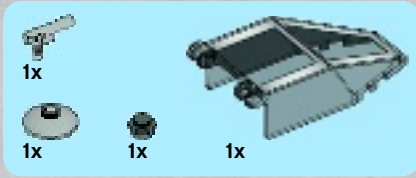
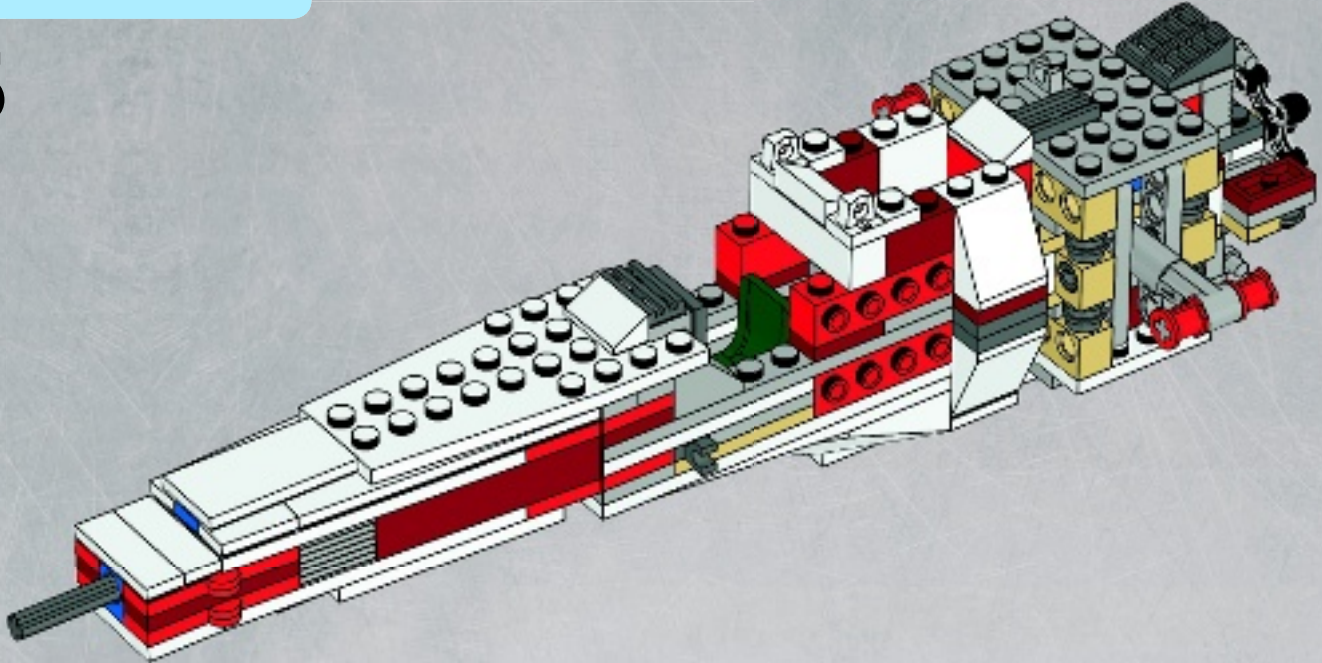

26

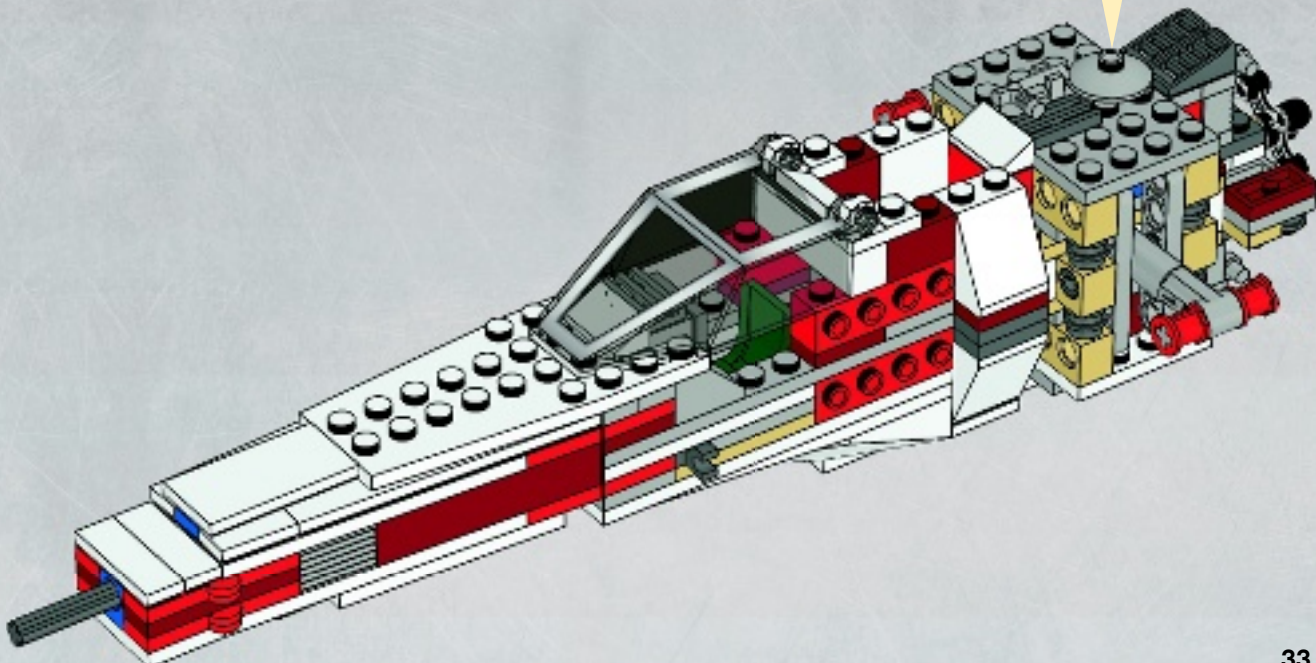
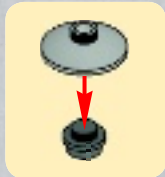

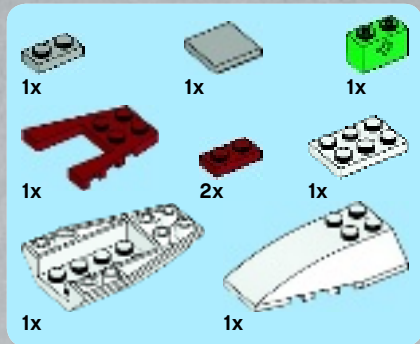

27

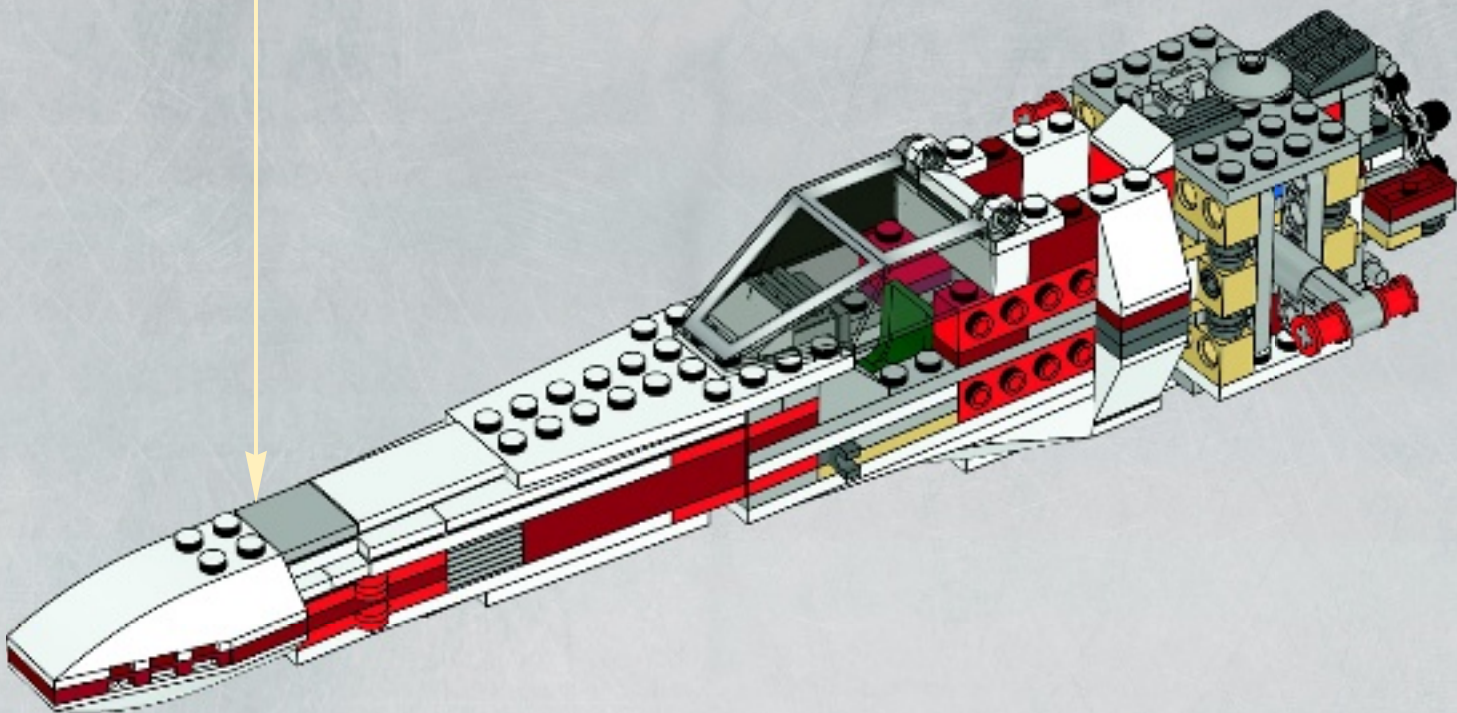
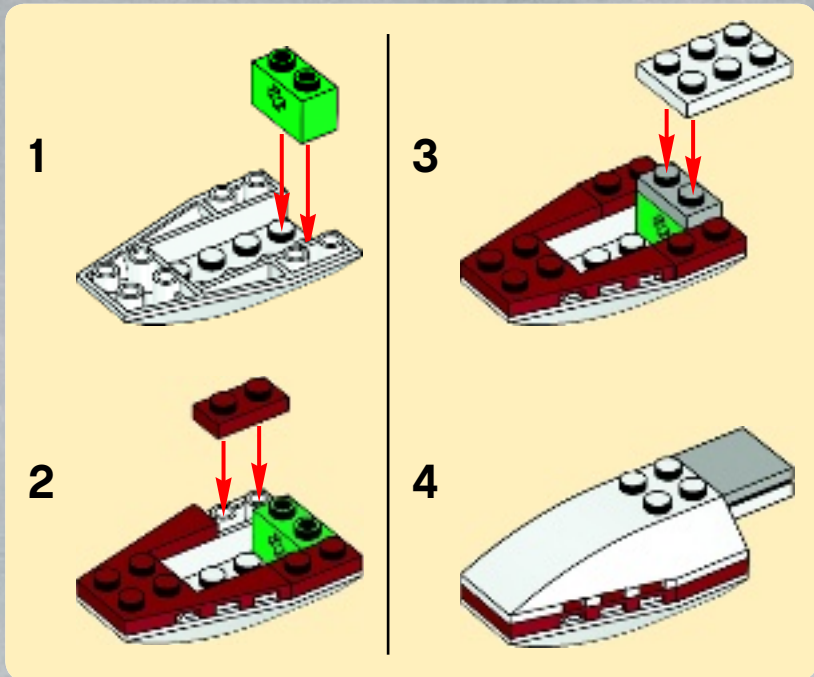

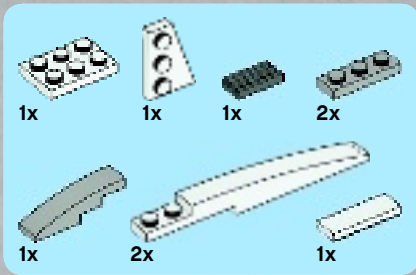

28

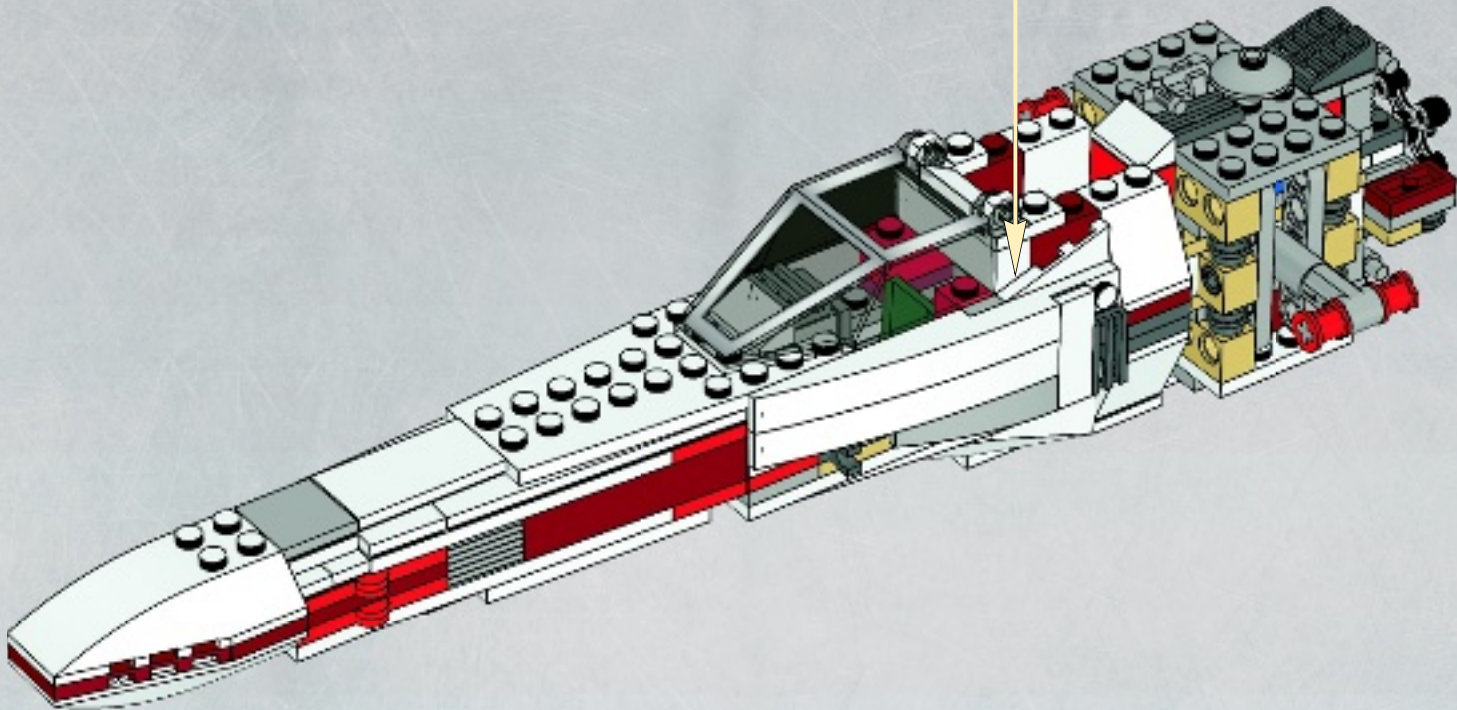
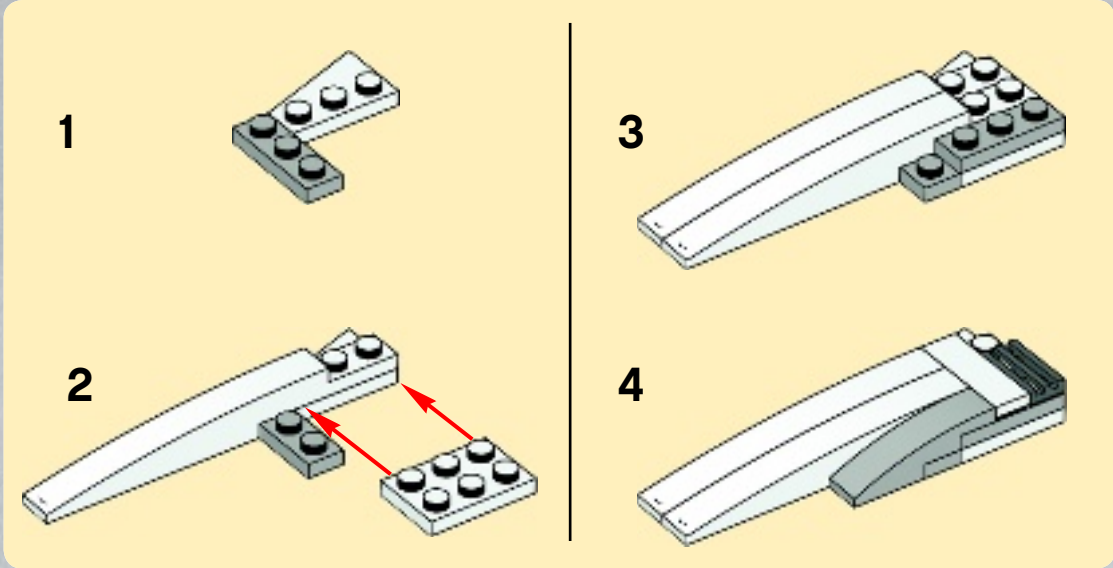

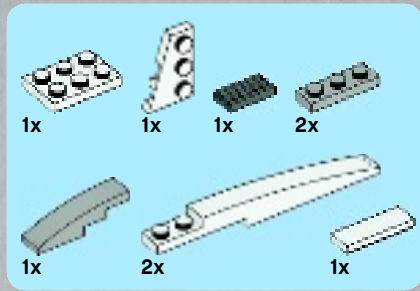

29

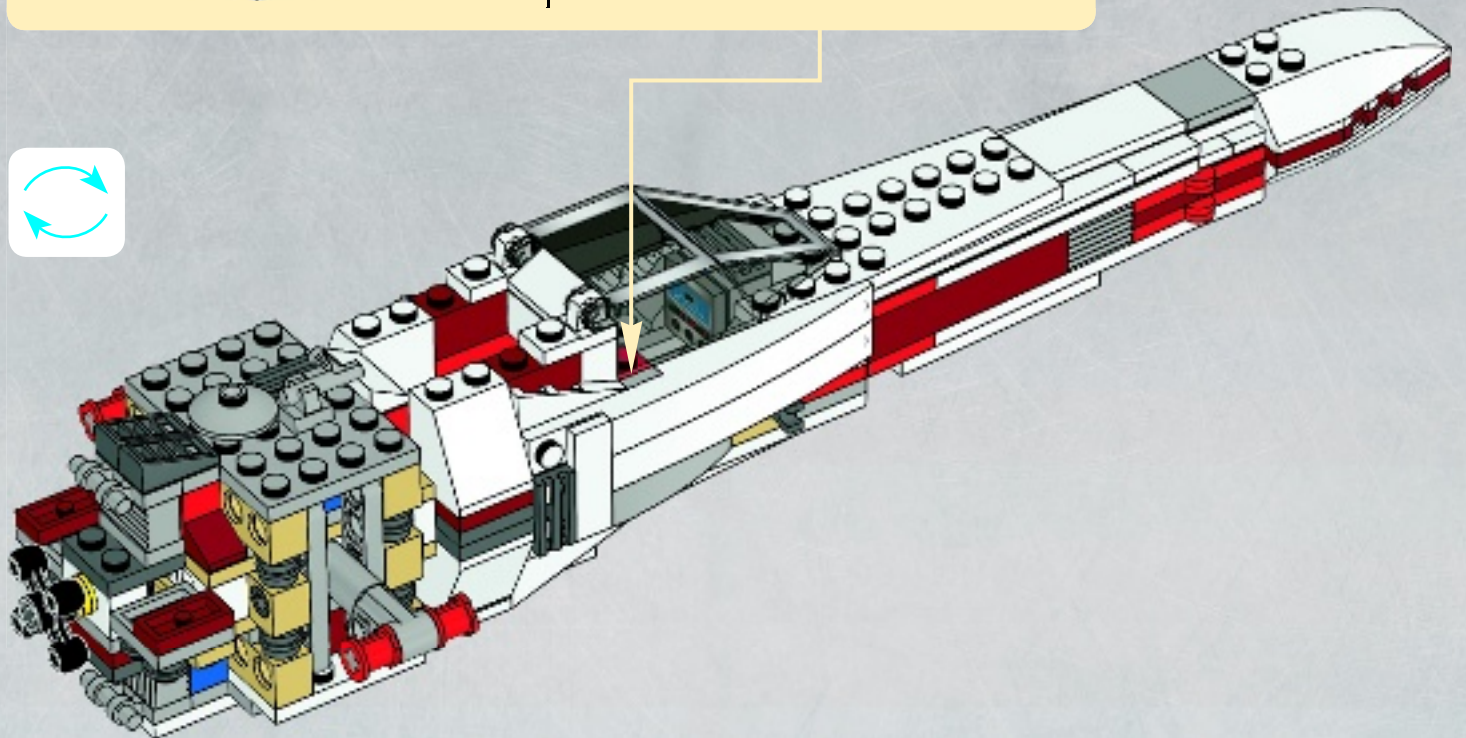
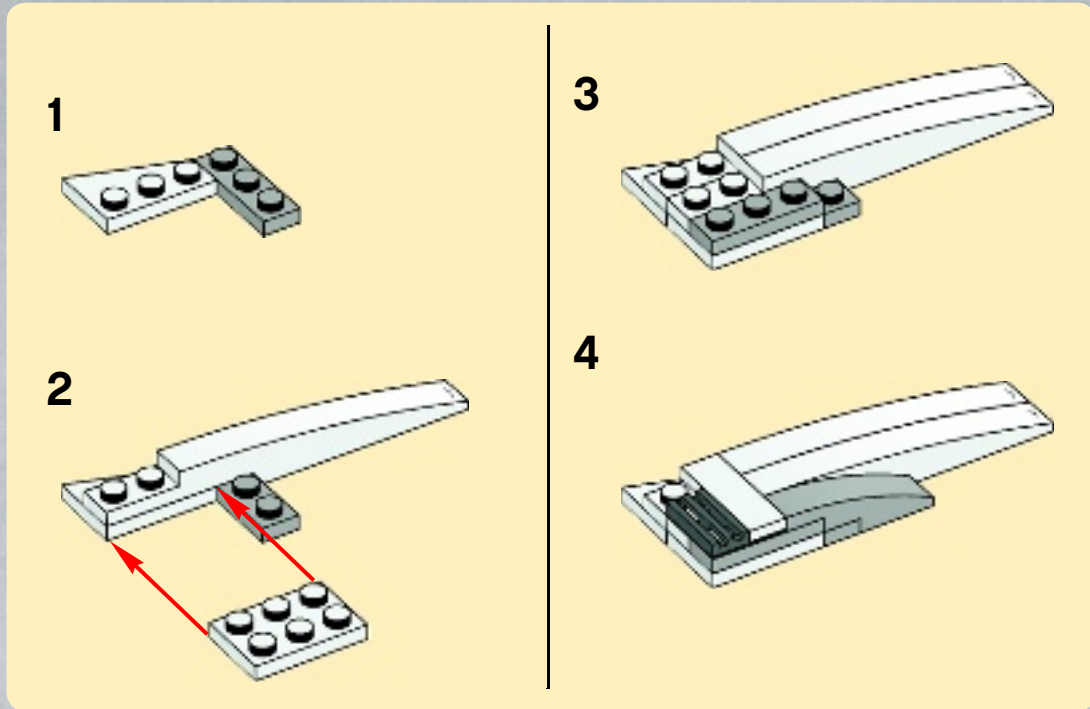



3



2x

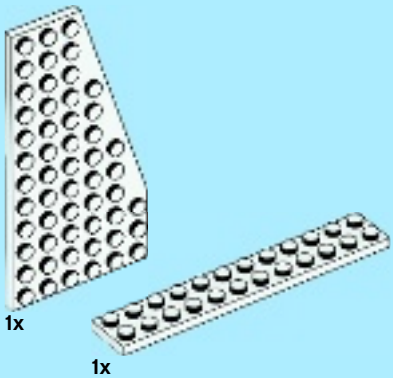

1x

1x

1

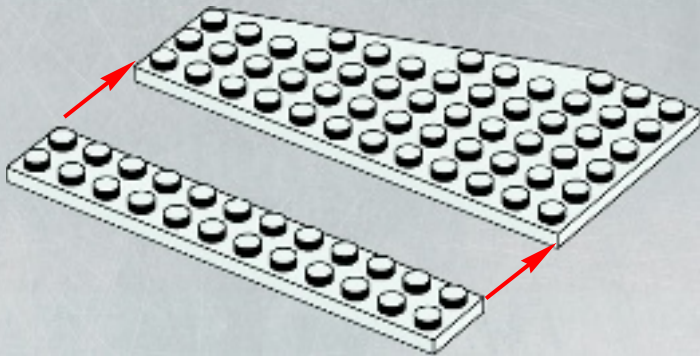

1x



1x

2

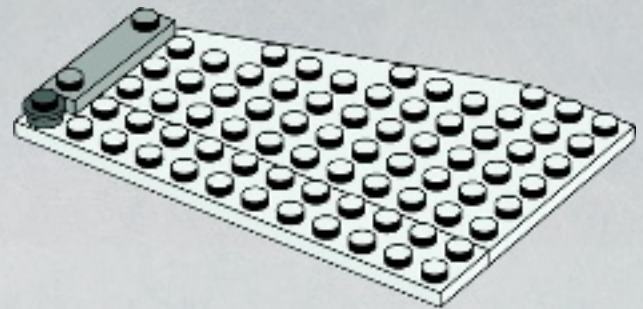

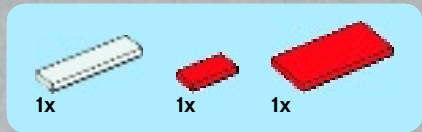

3

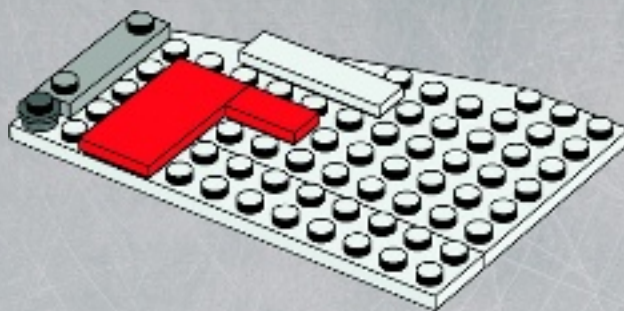

4

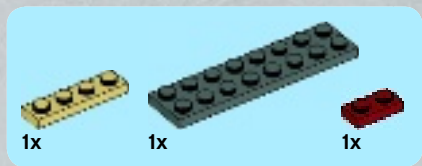
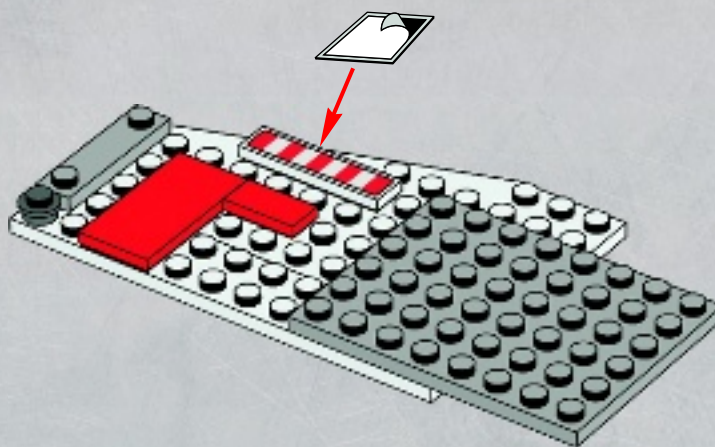

5

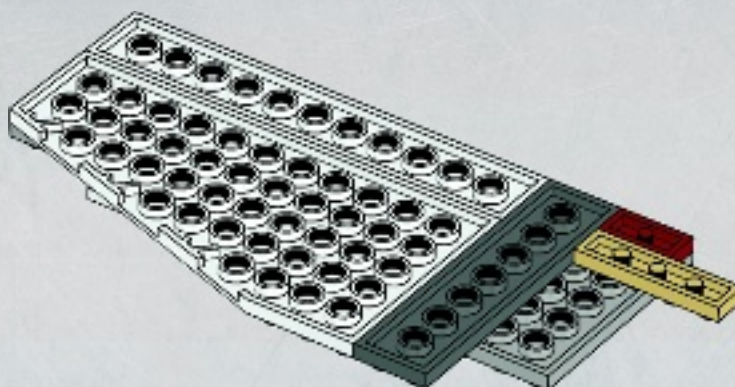



6

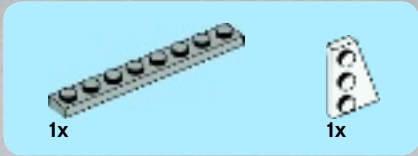
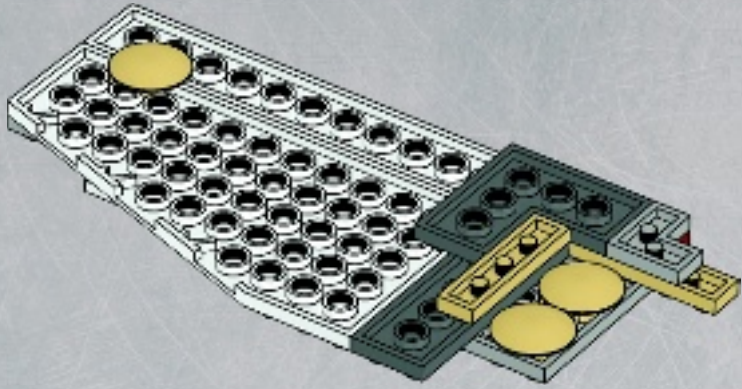

7

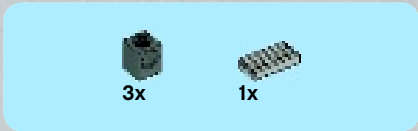
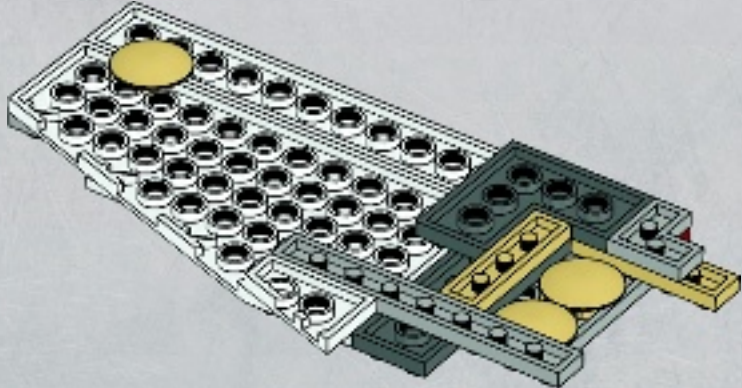

8

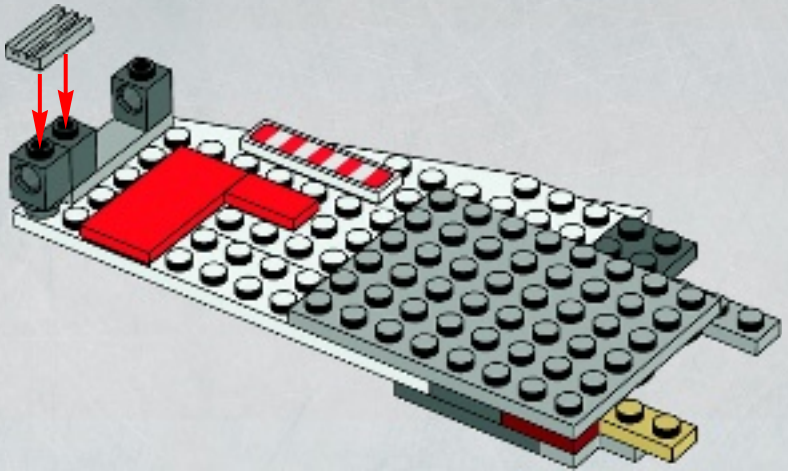

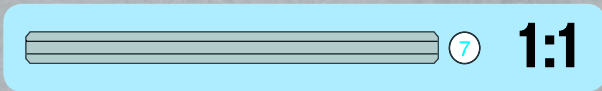
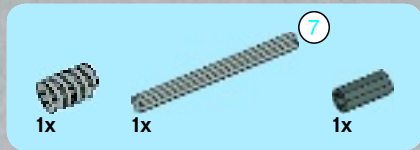

9

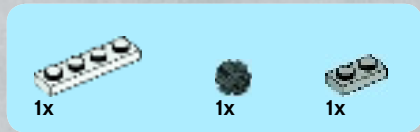
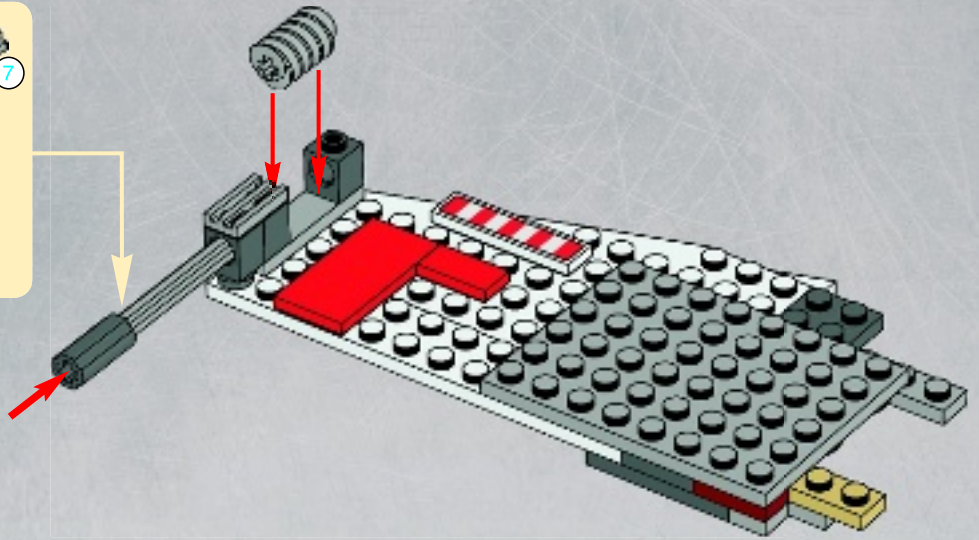
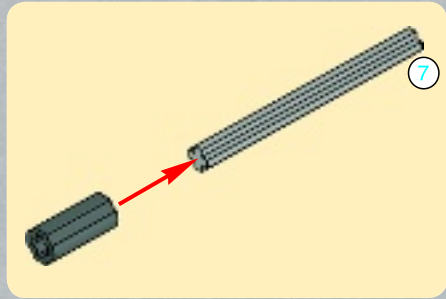

10

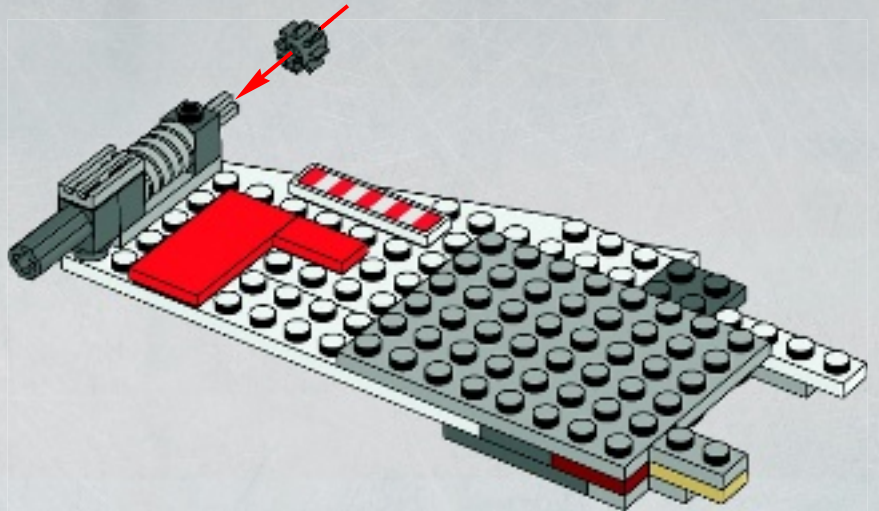

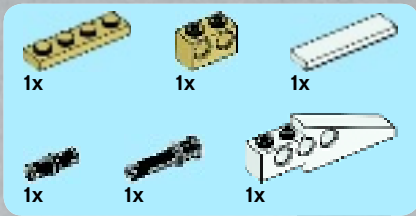

11

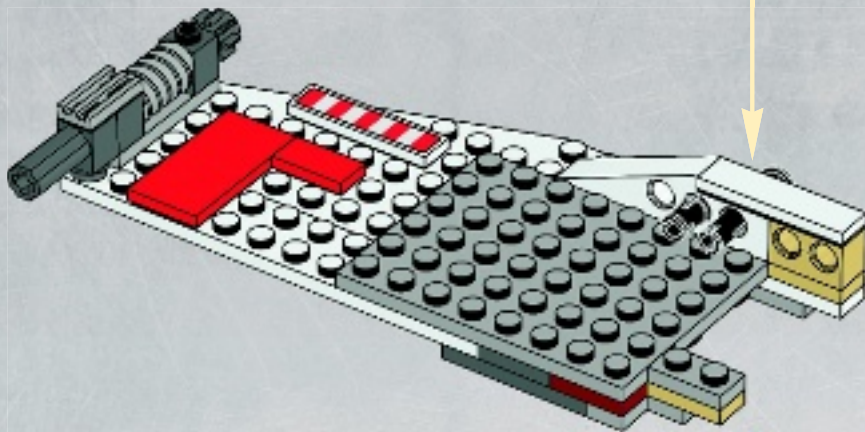
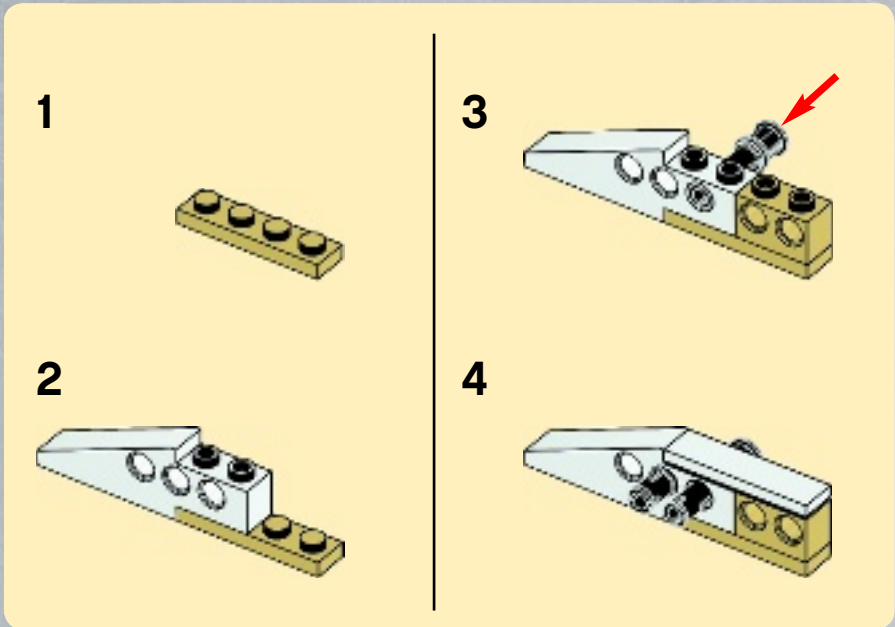



12

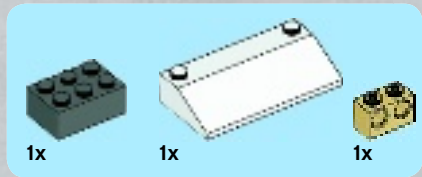
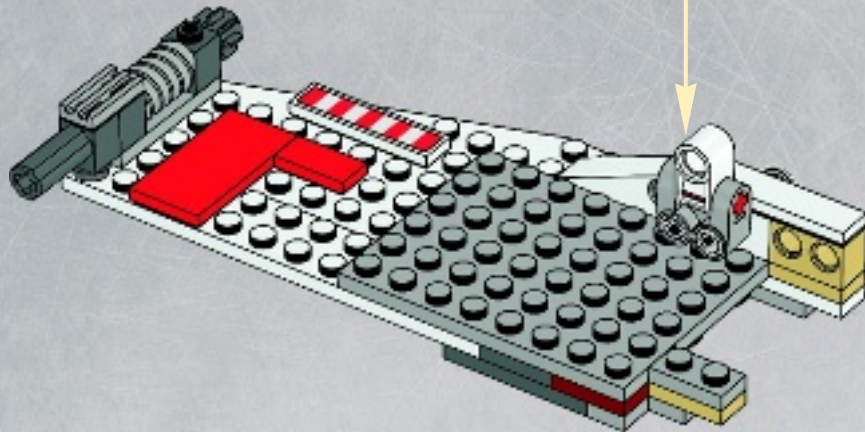
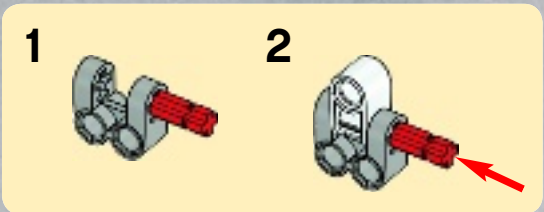

13

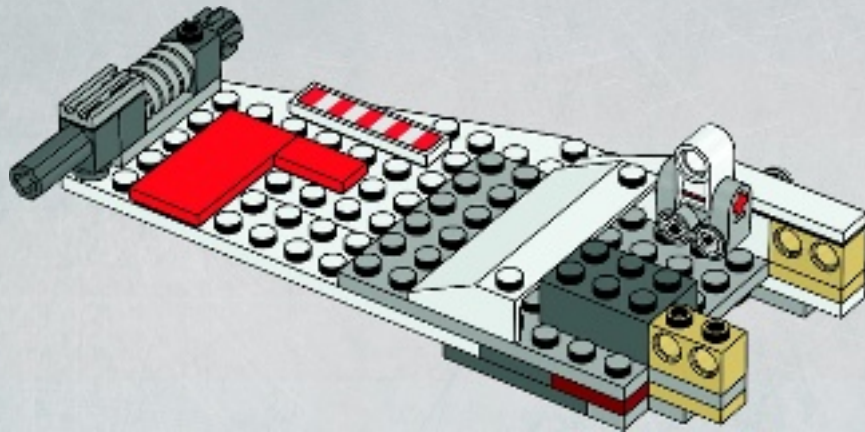

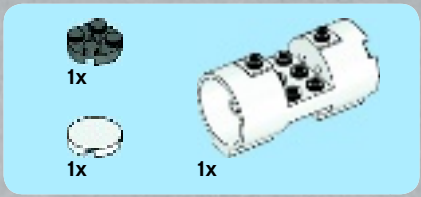

14

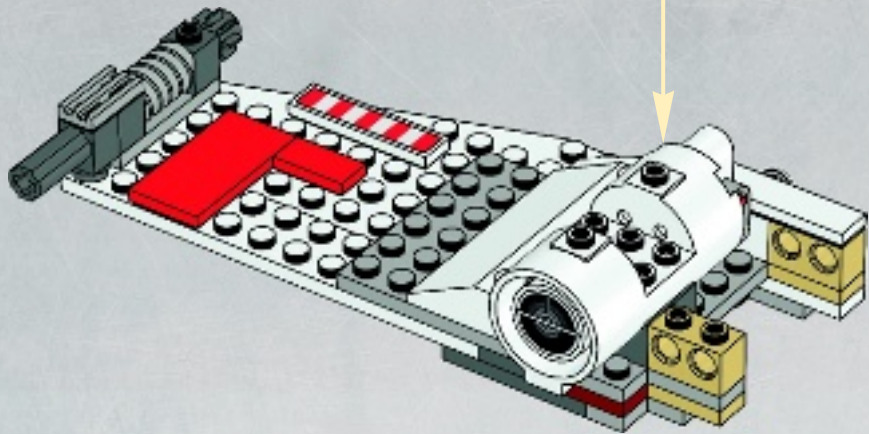
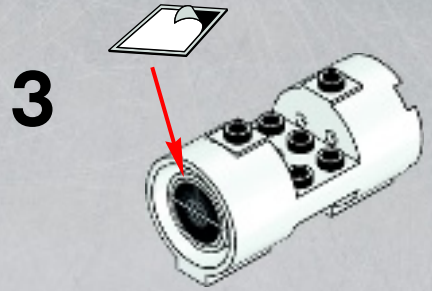
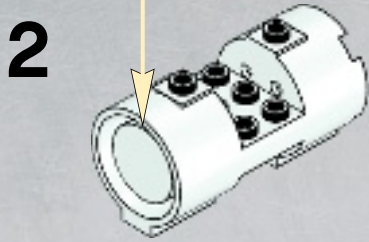
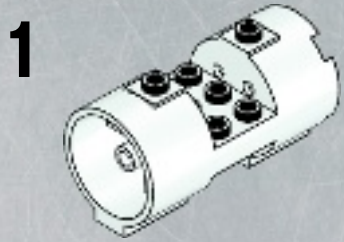
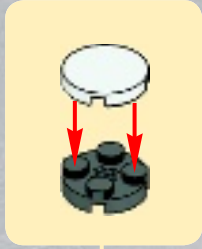



1x



1x



1x

15

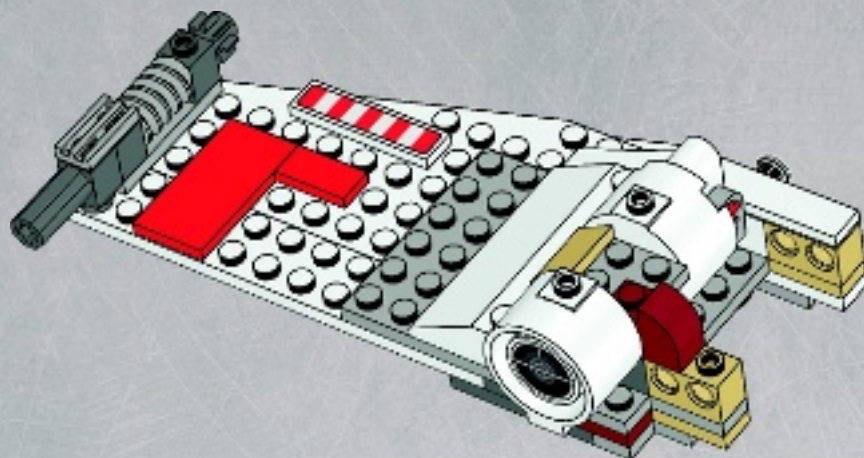

1x

16

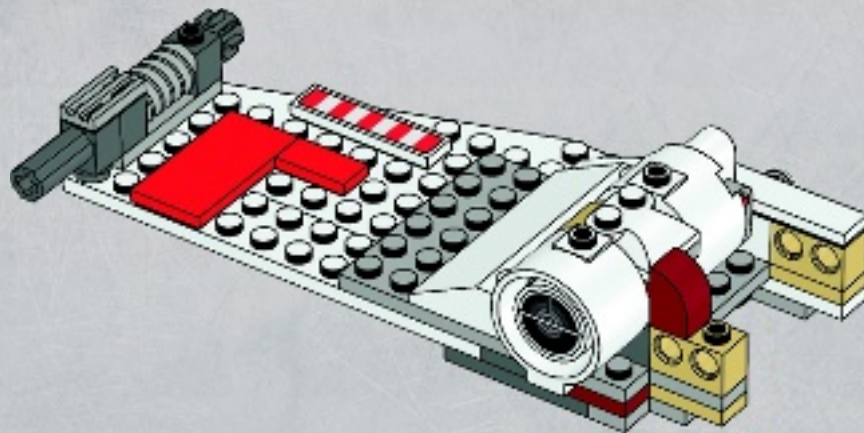

1x

17

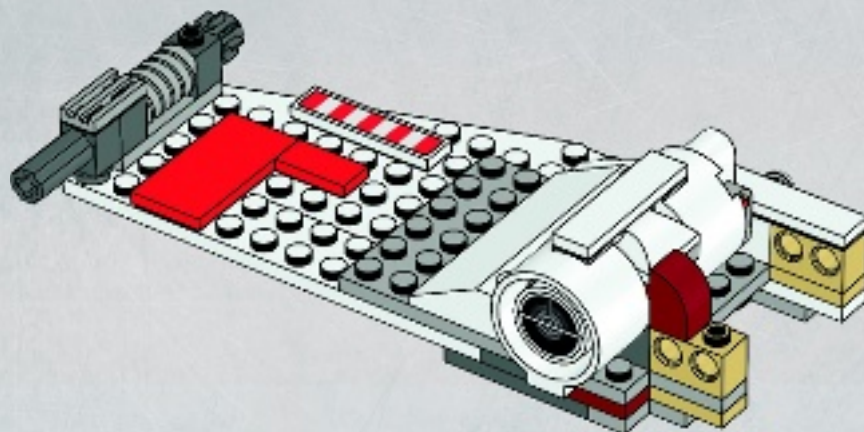

2x

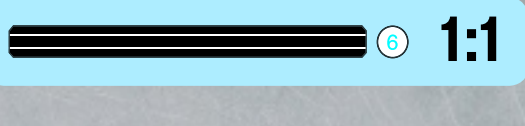
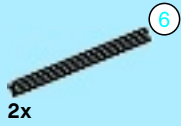

18

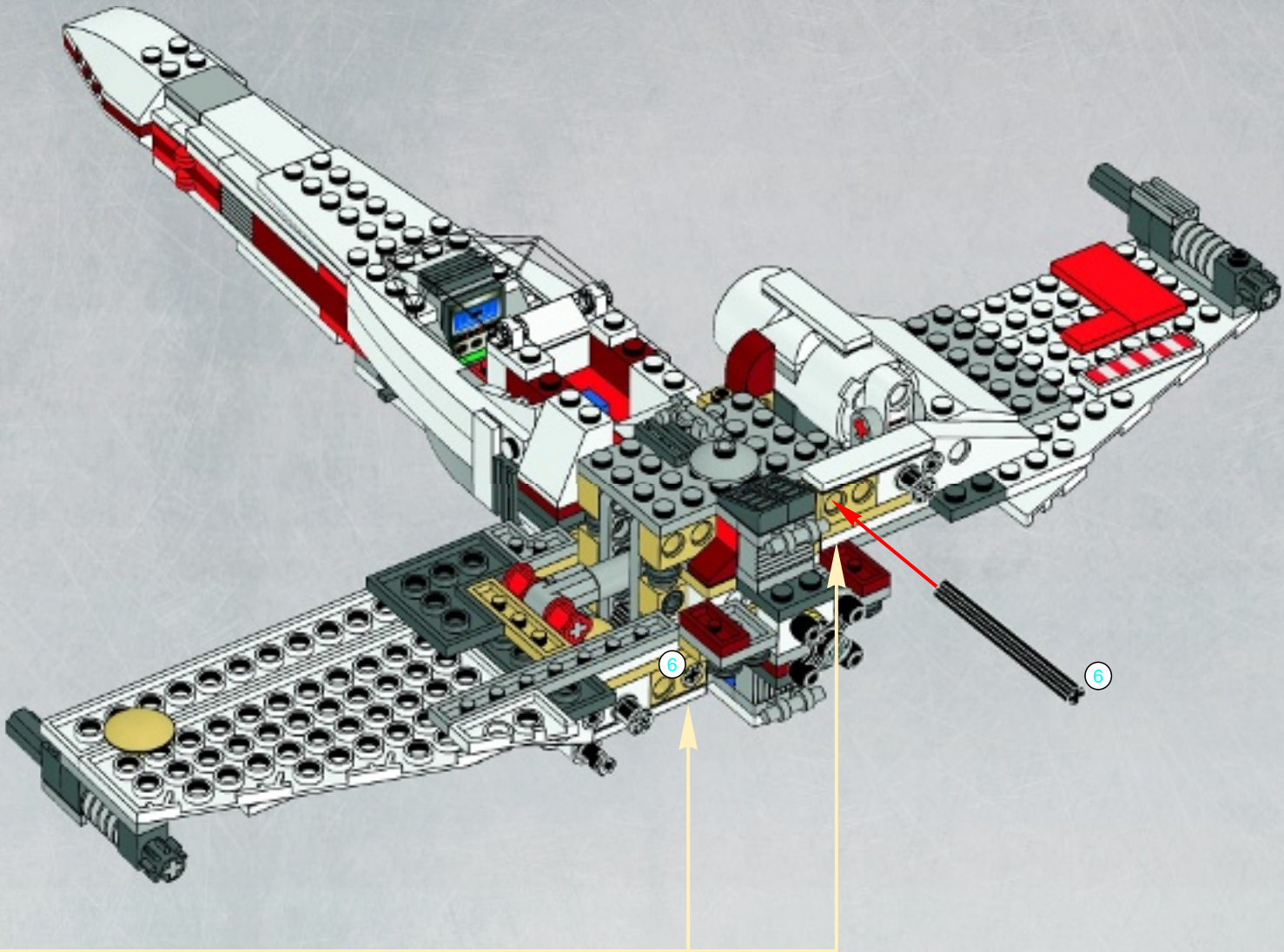

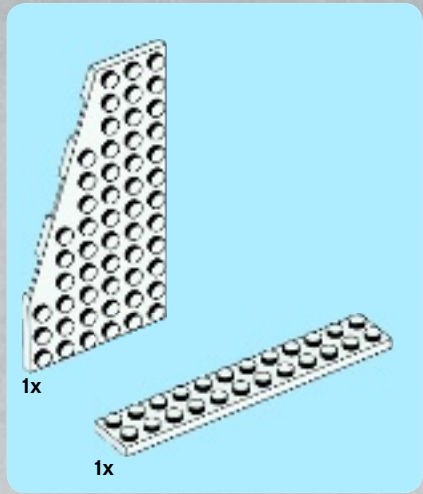
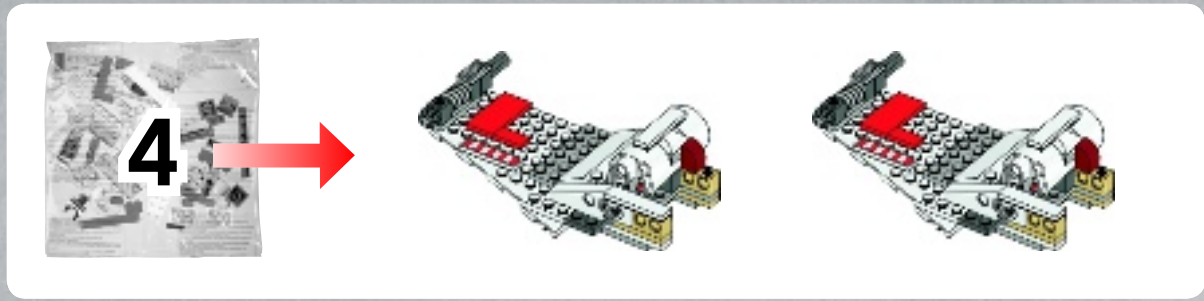

1

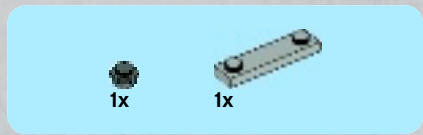
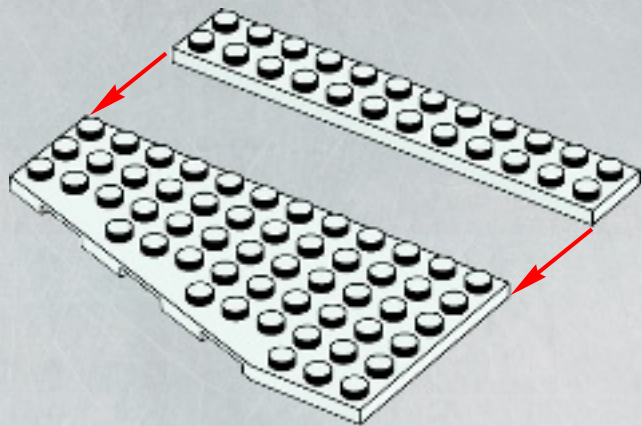

2

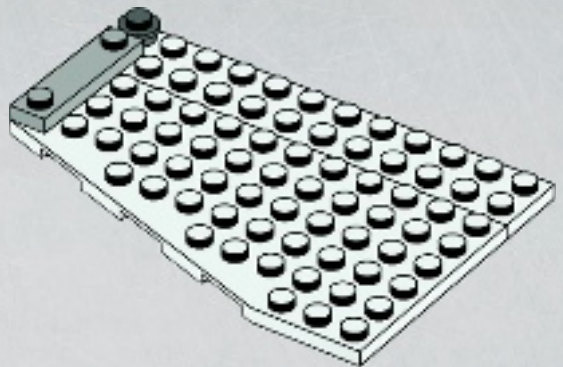

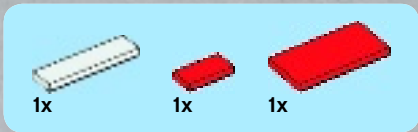

3

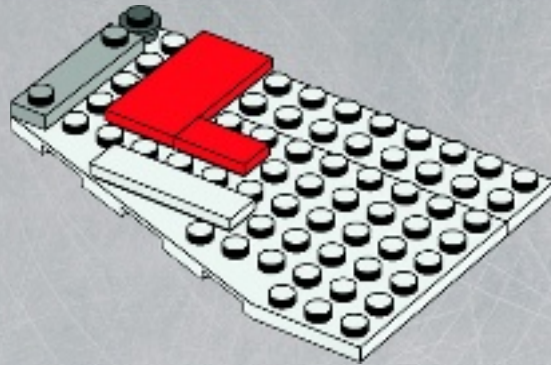

4

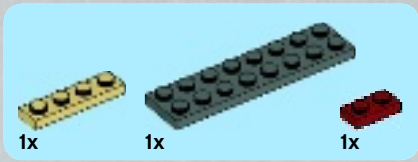
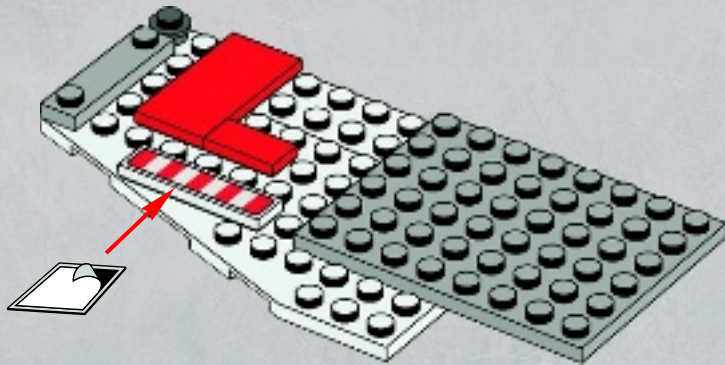

5

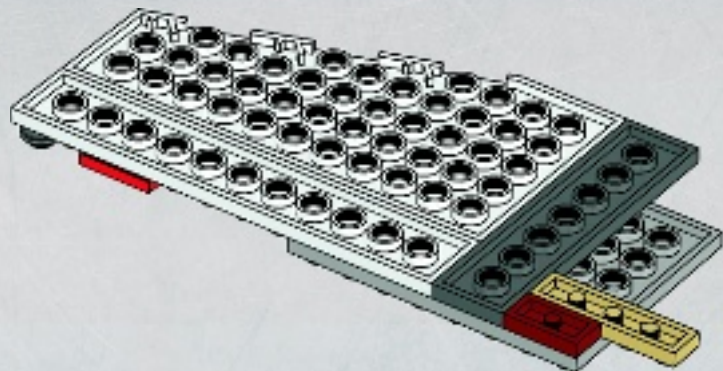



6

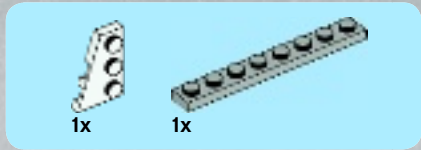
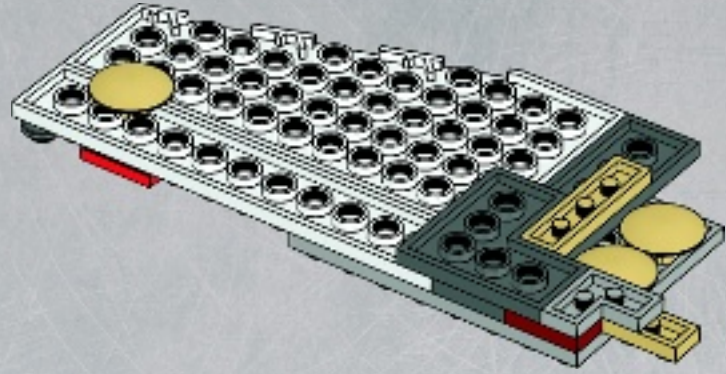

7

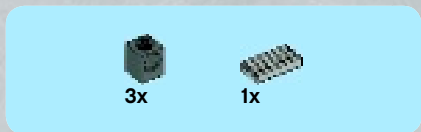
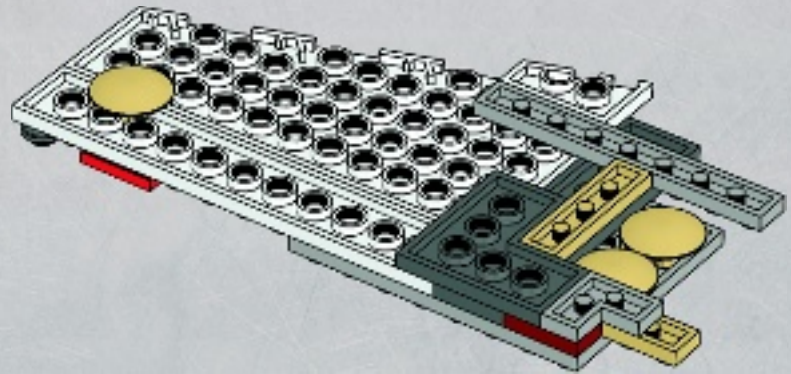

8

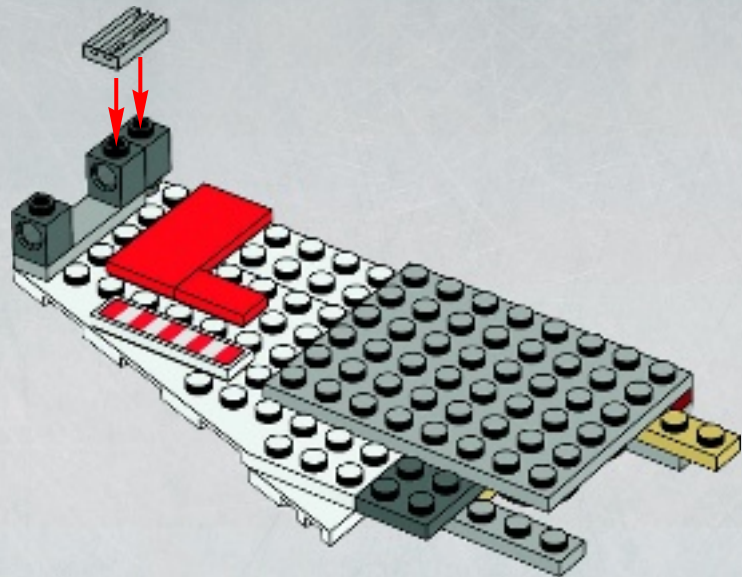

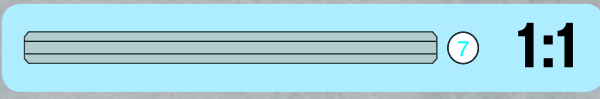
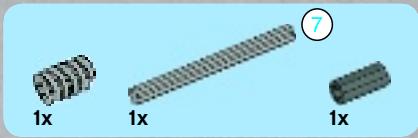

9

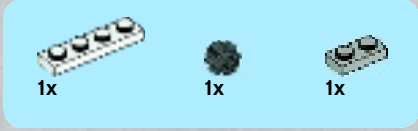
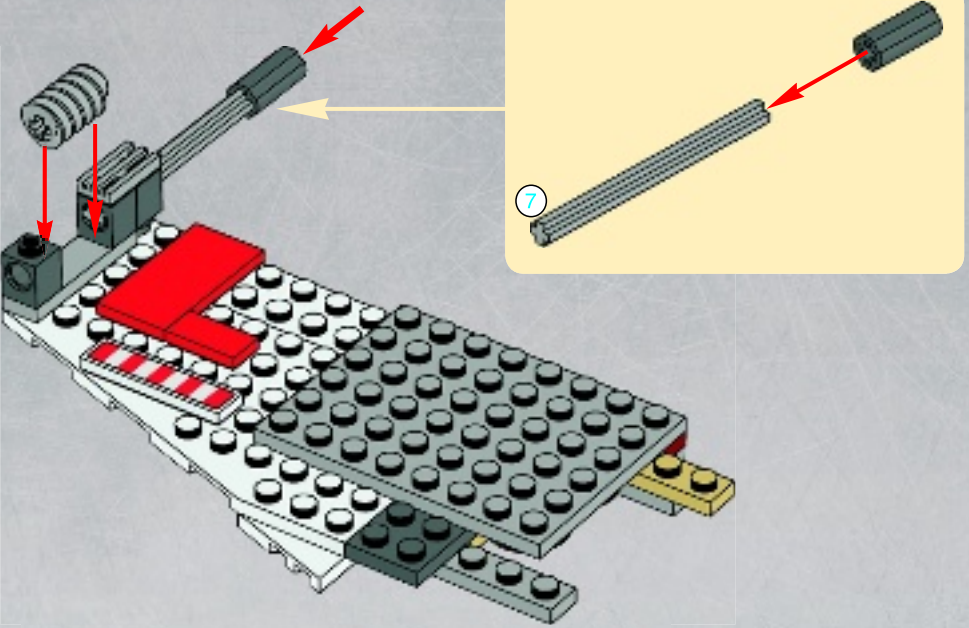

10

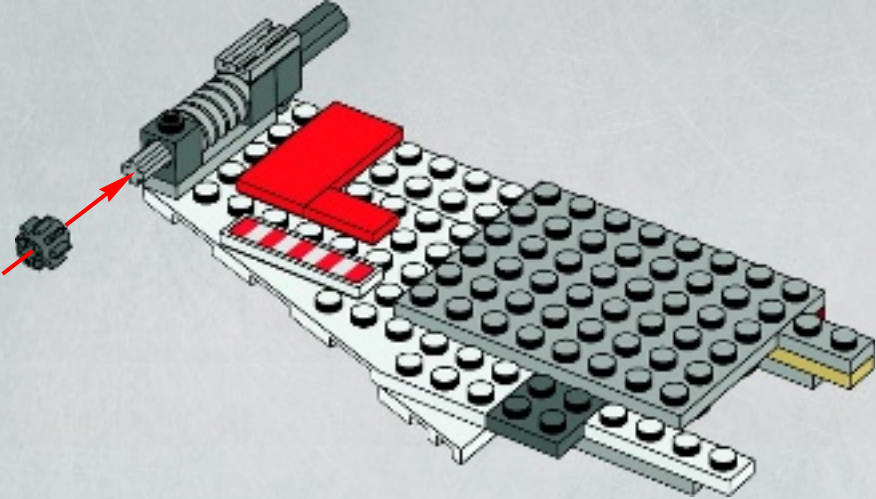

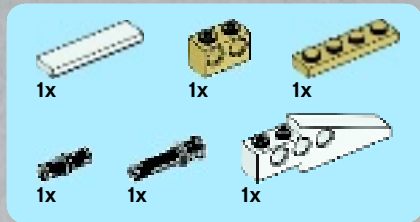

11

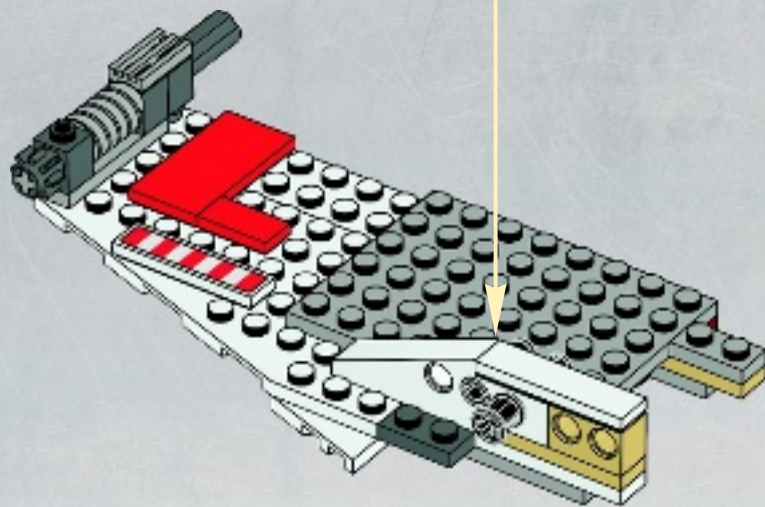
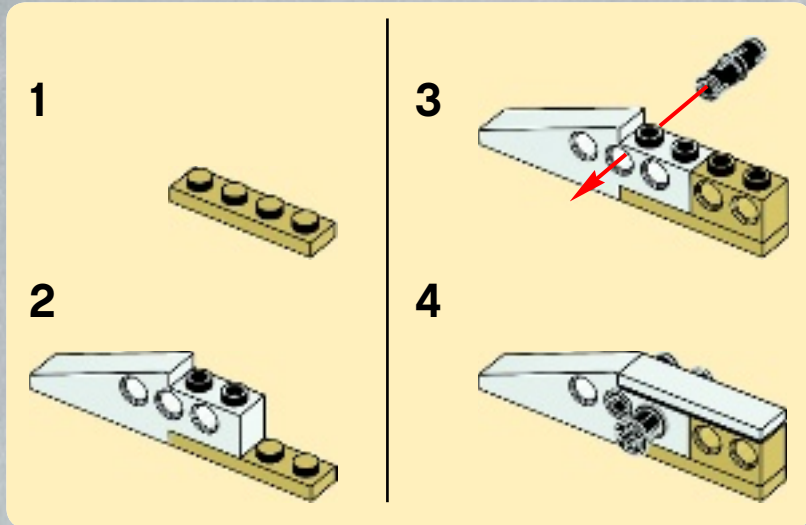



12

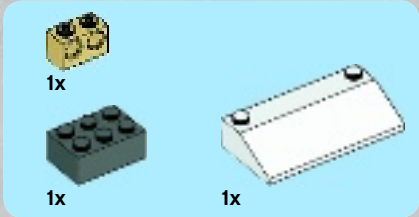
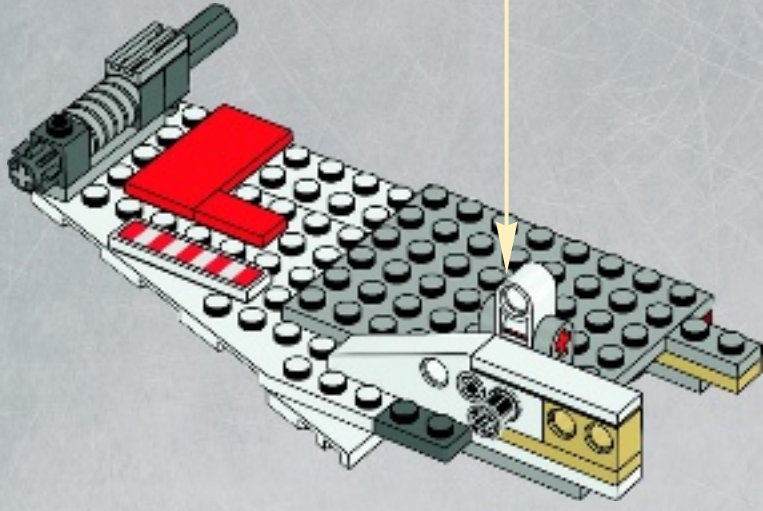
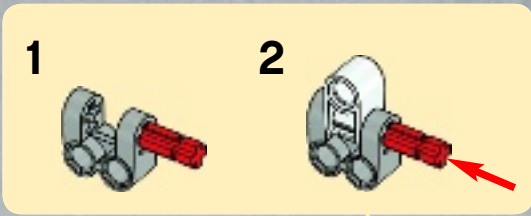

13

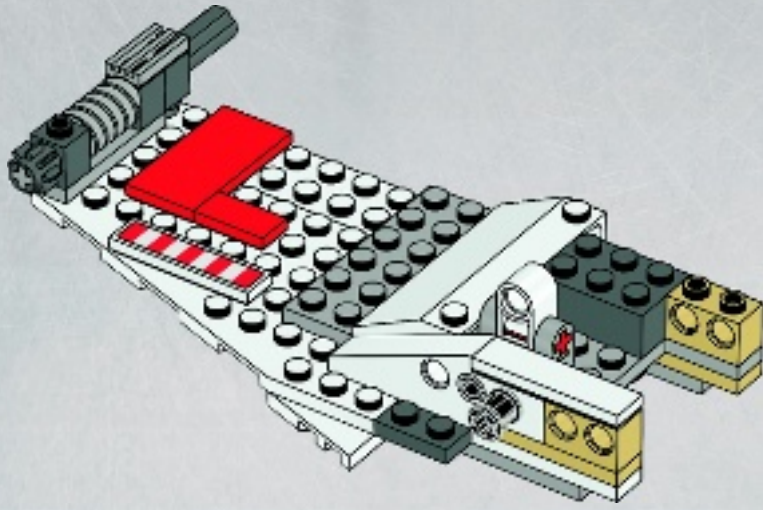

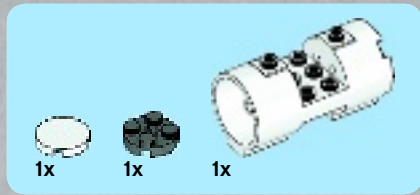

14

1

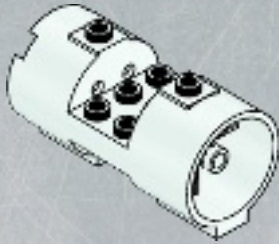

2

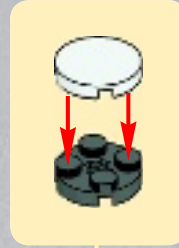
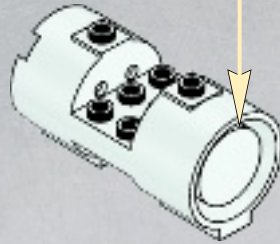

3

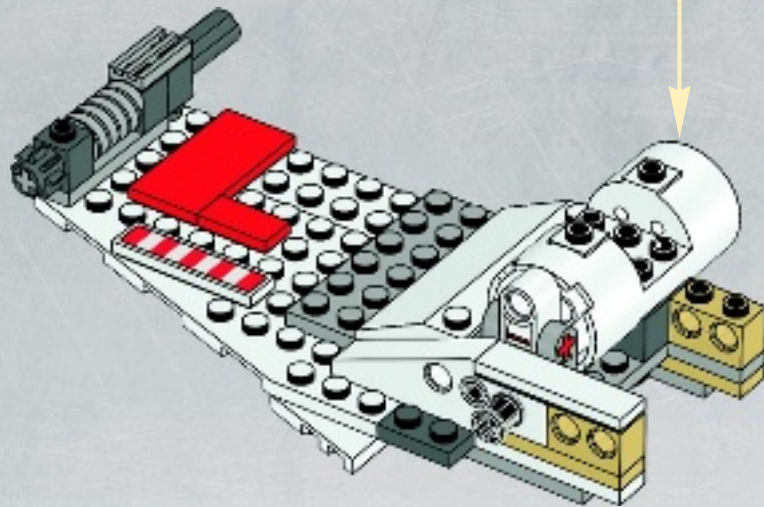
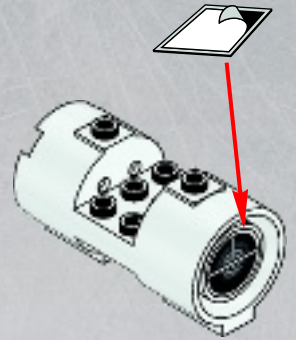

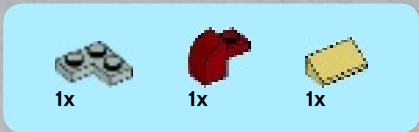

15

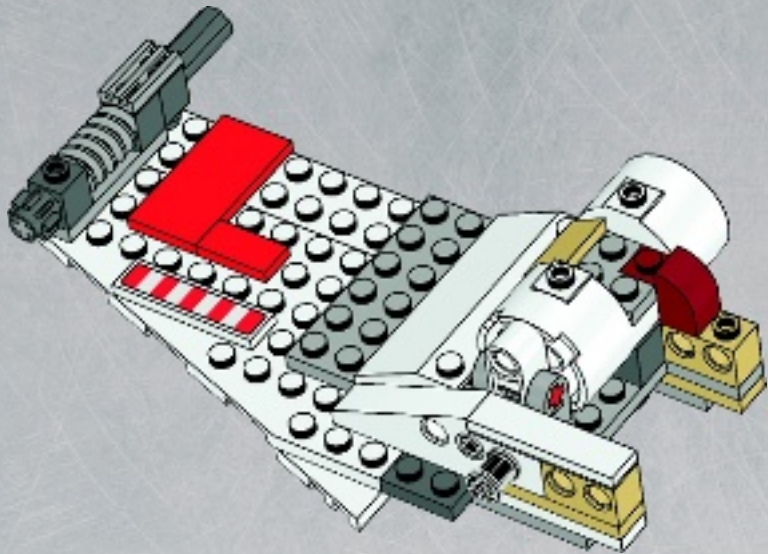

16

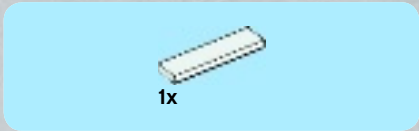
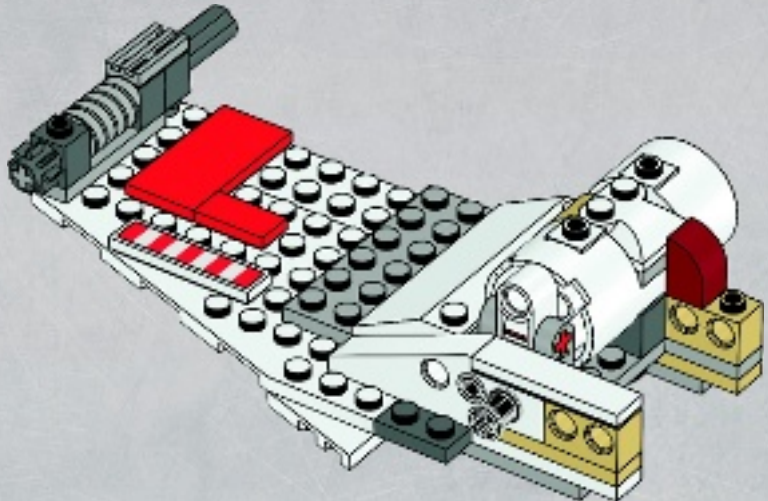

17

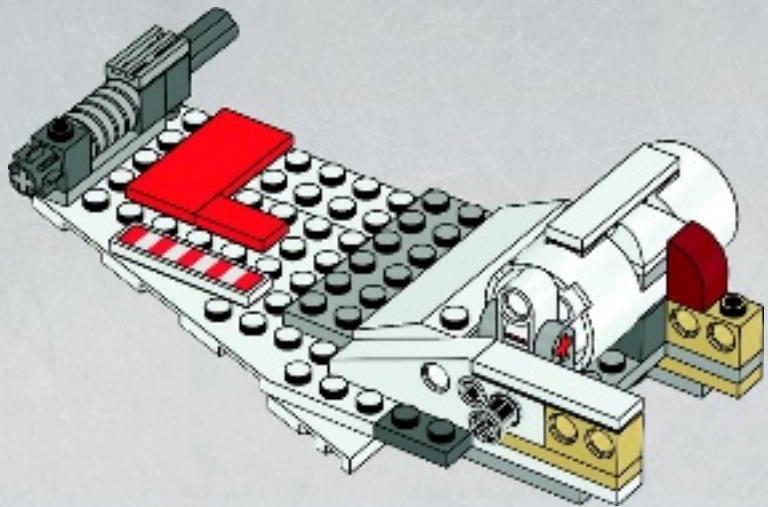

2x

6



2x



6

1:1

18

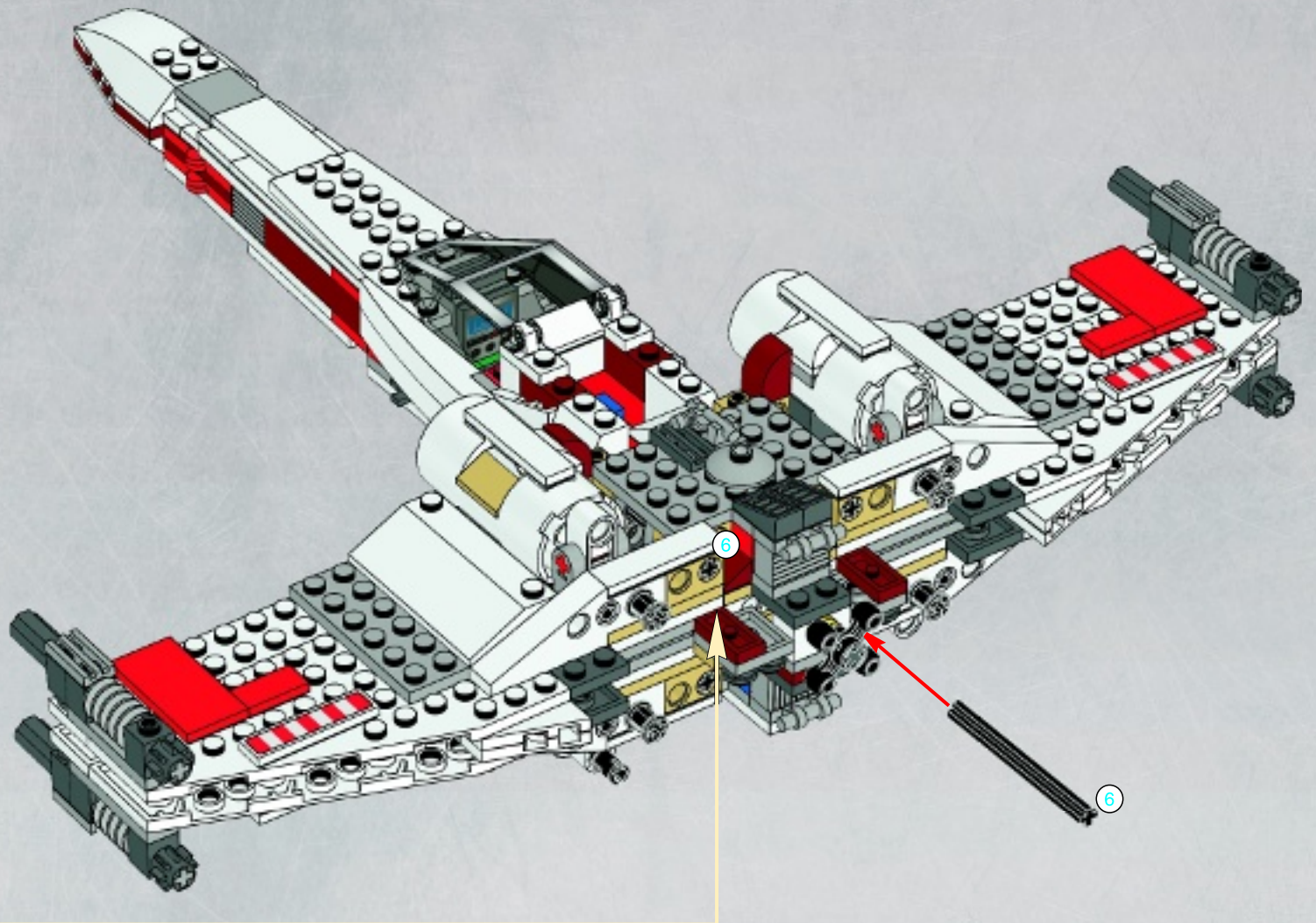



2x



2x

20

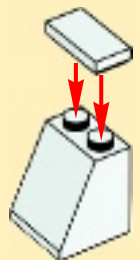
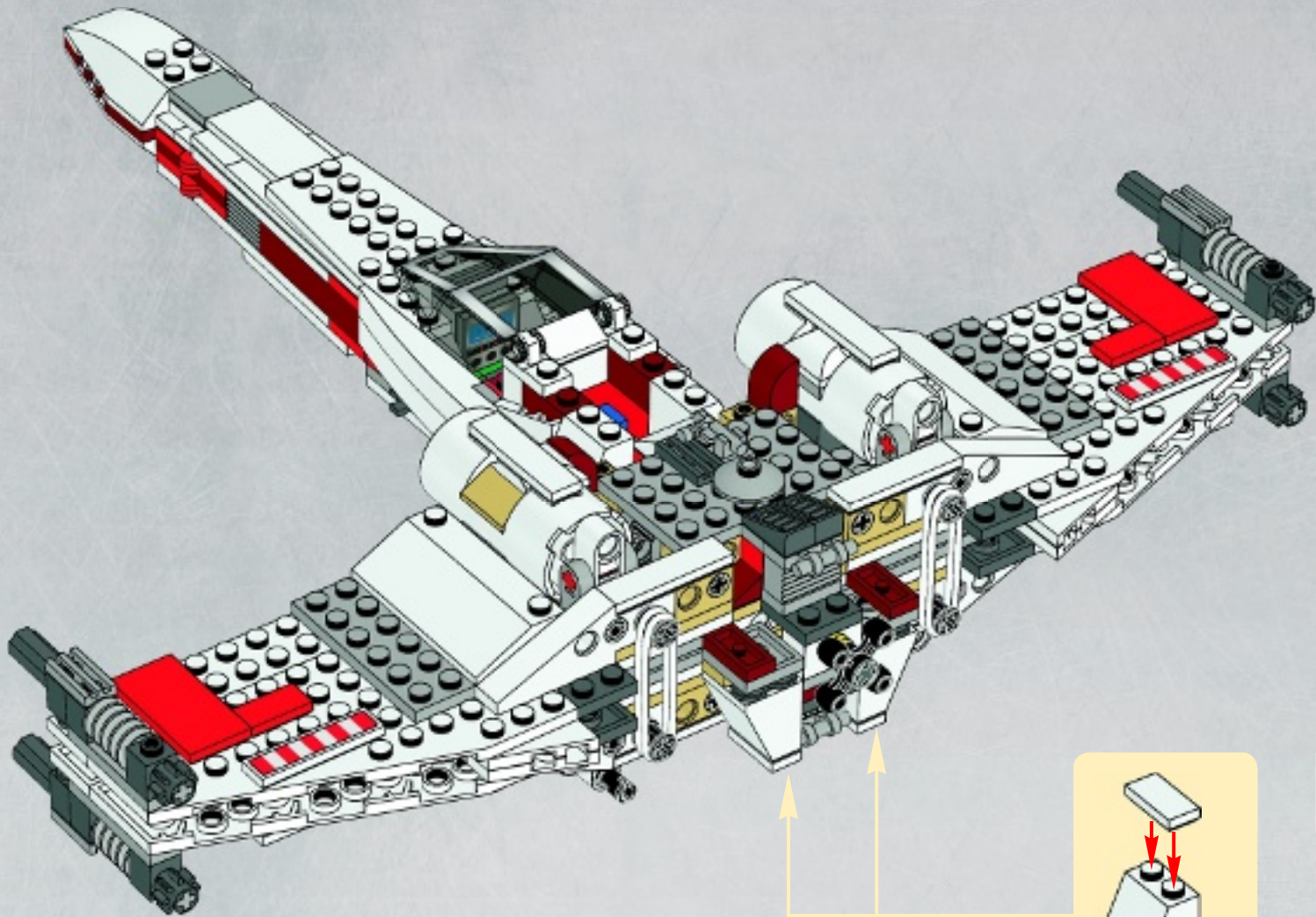

2x

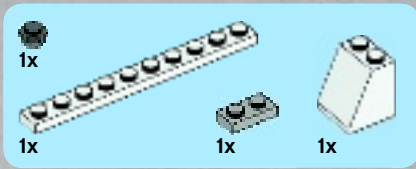

21

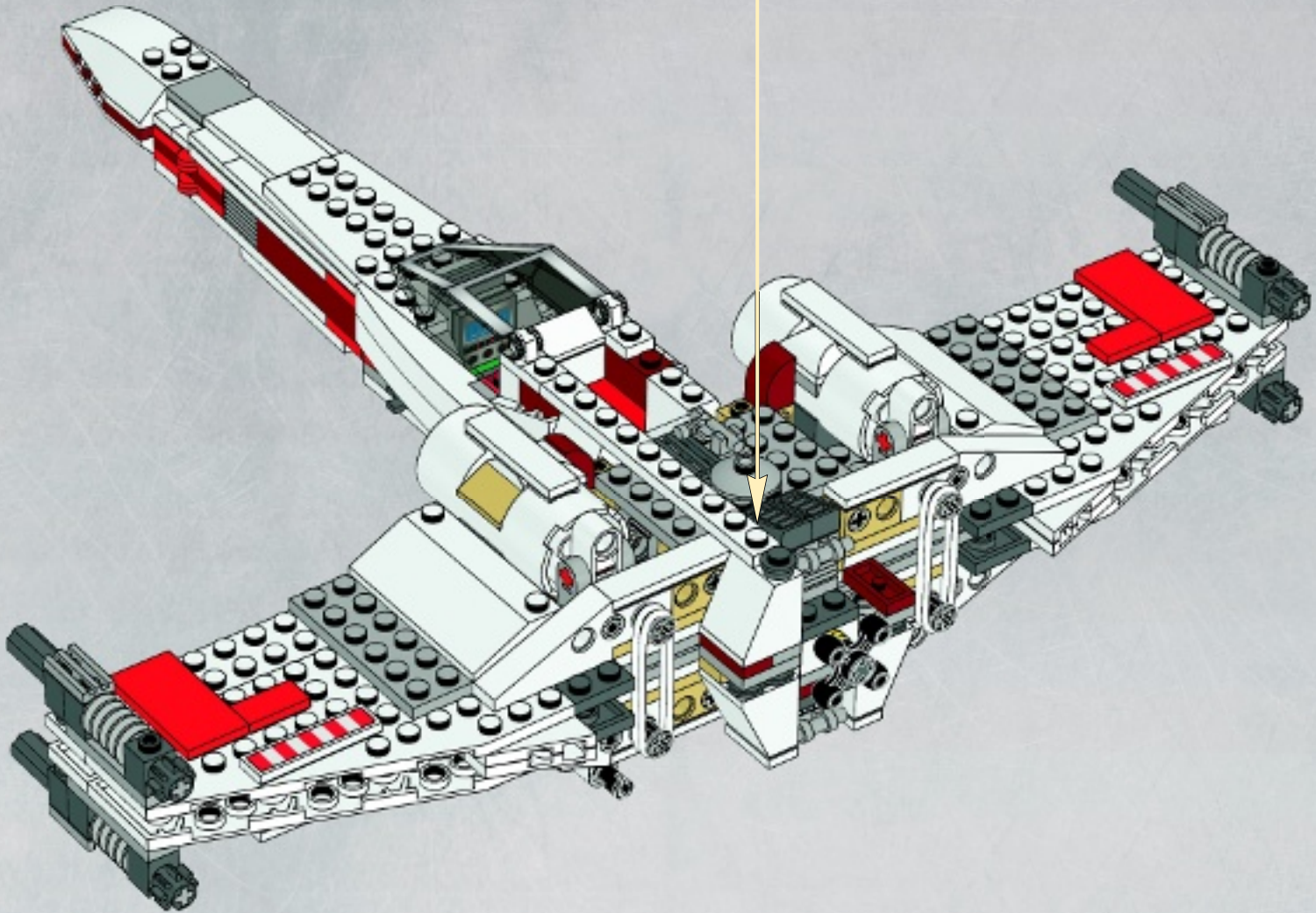
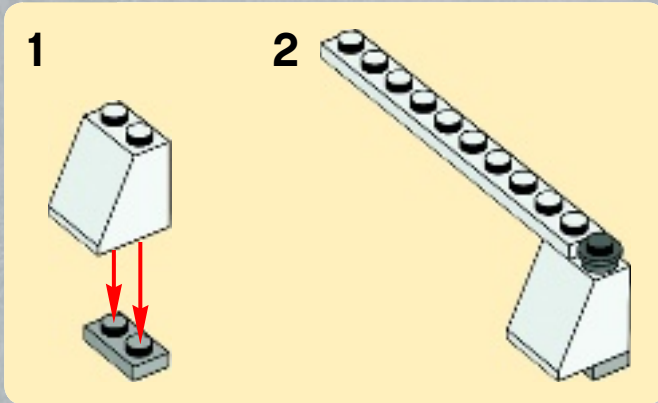

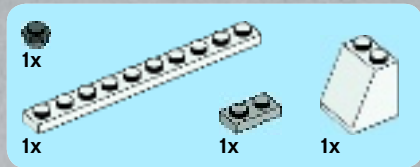

22

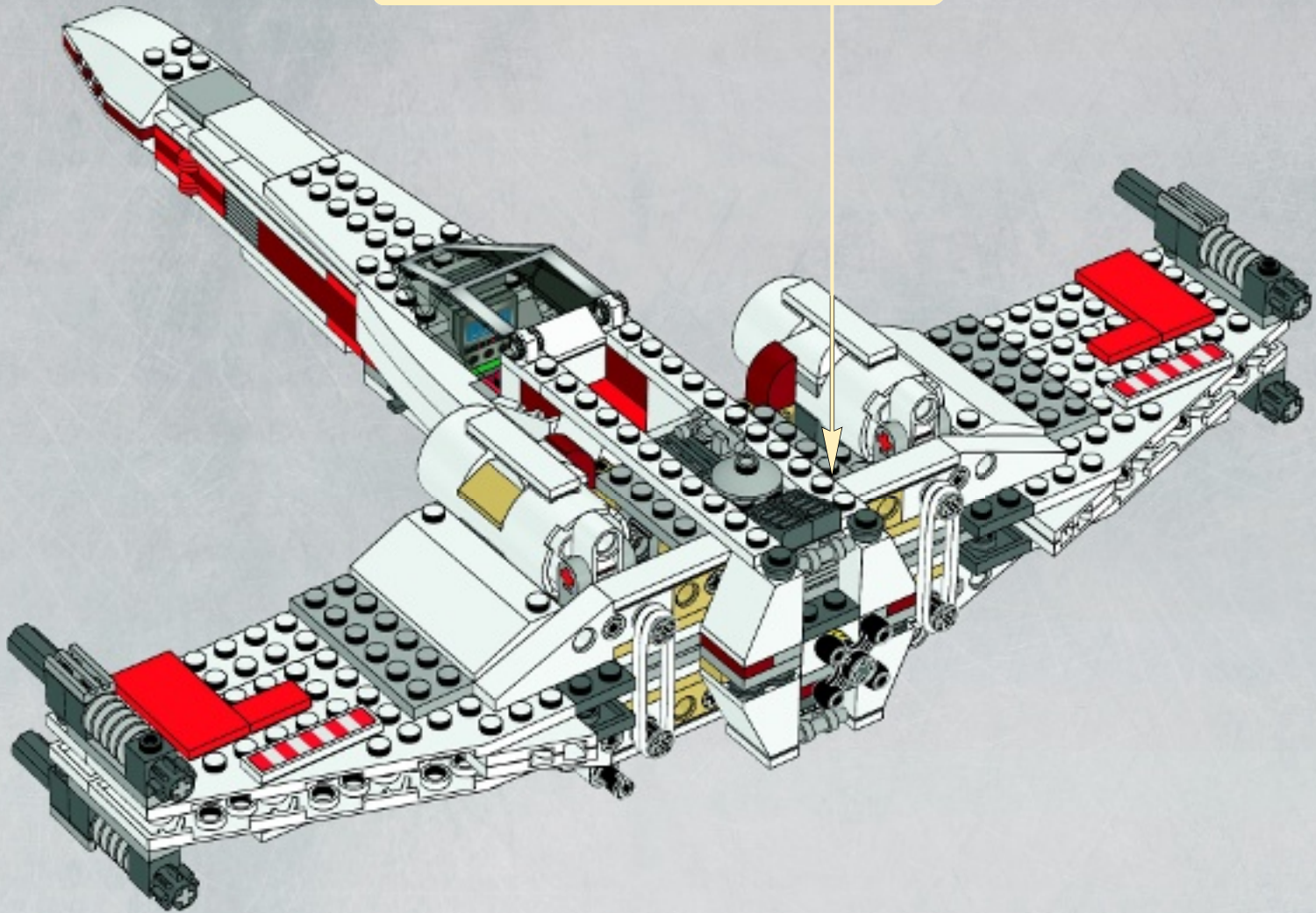
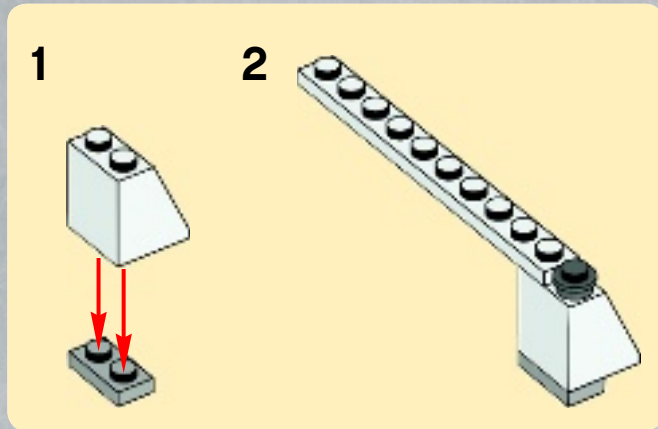



4x

23

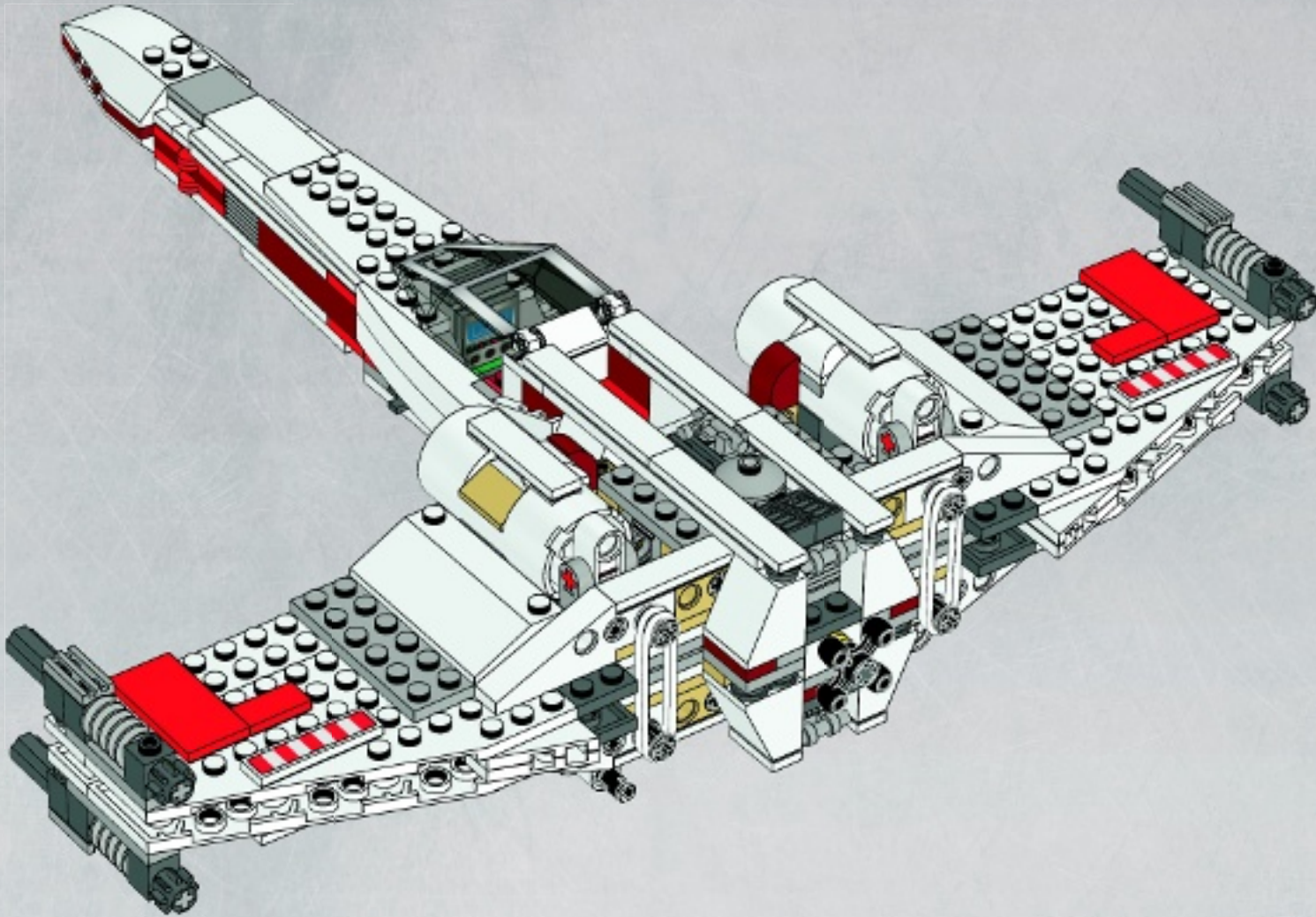

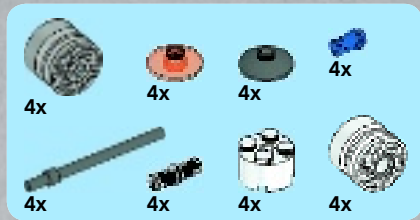

24

1



2

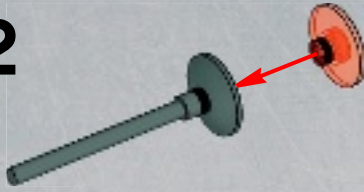

3

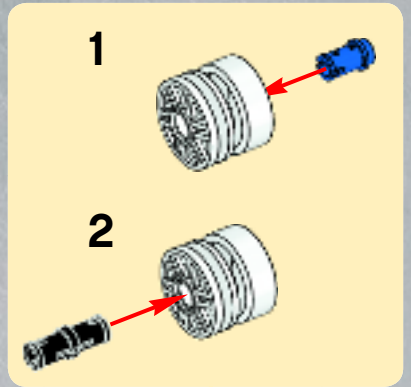
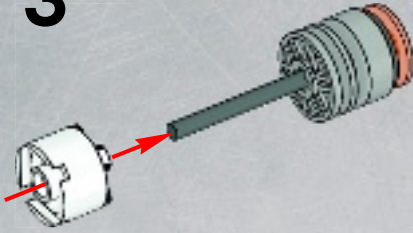

4

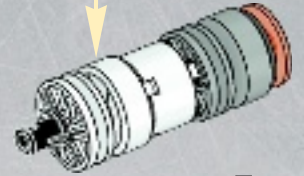

4x

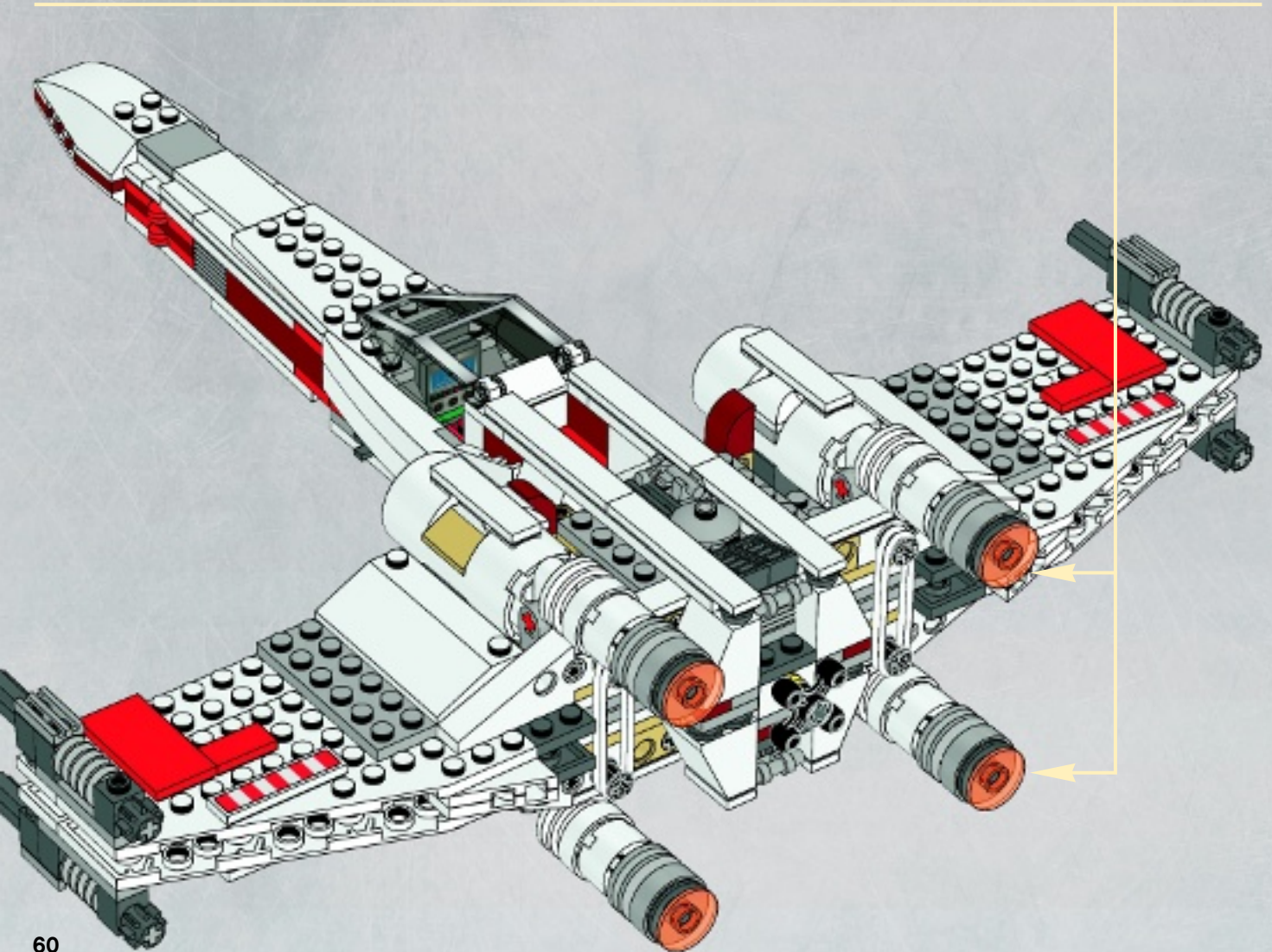

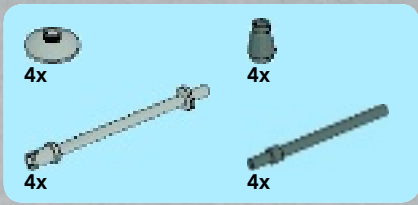

25

1

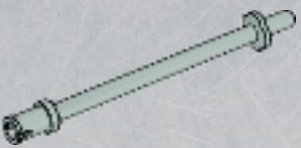

2

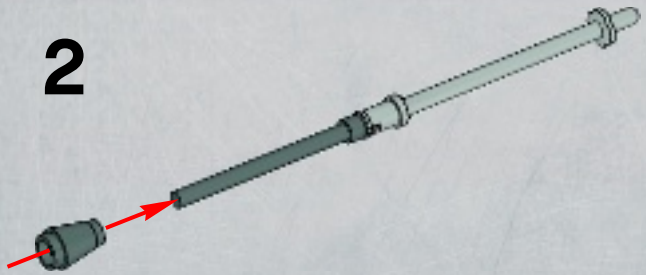

3

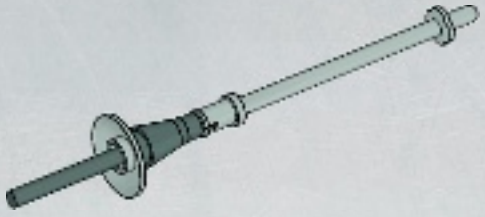

4x

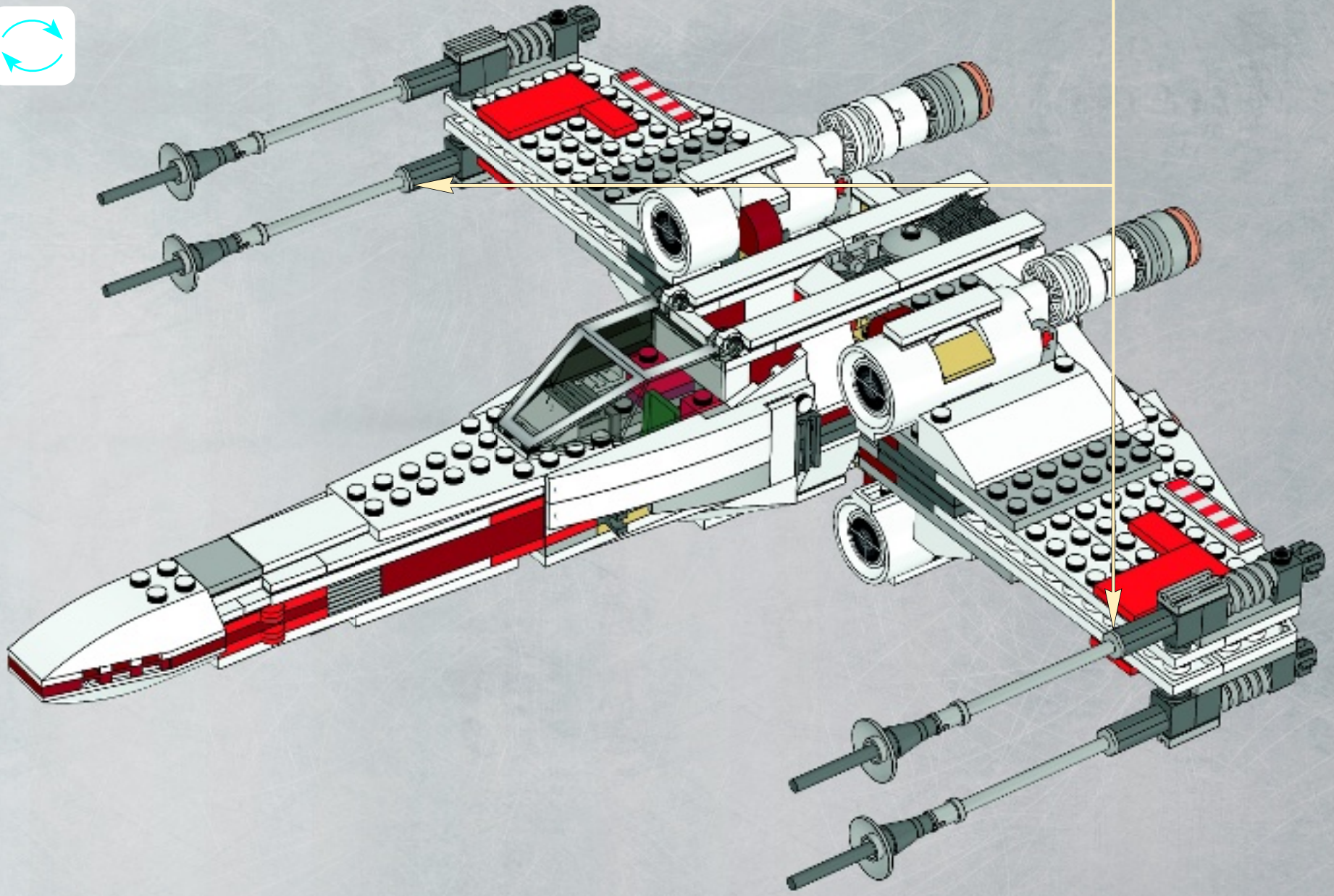



2x



2x

26

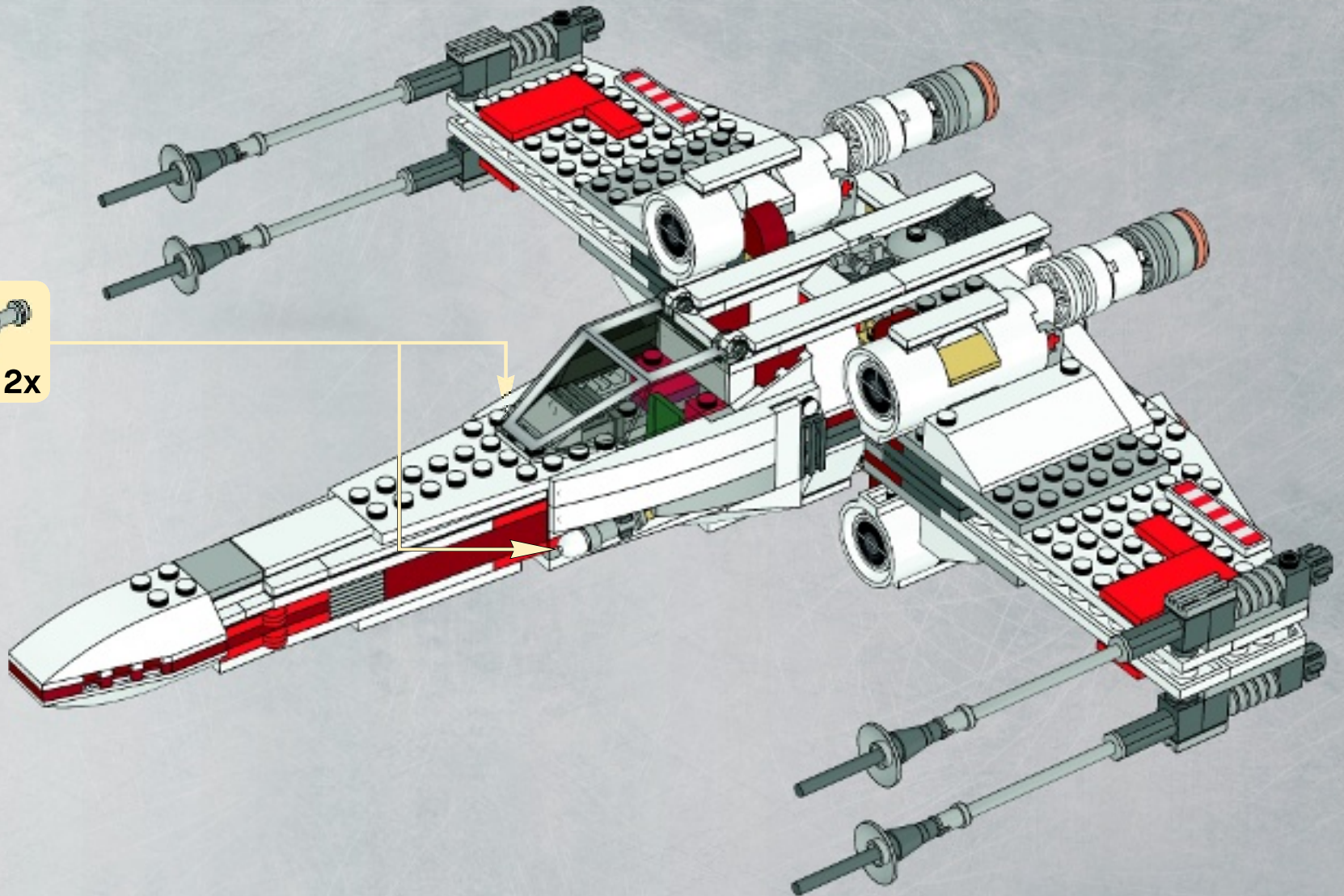

27

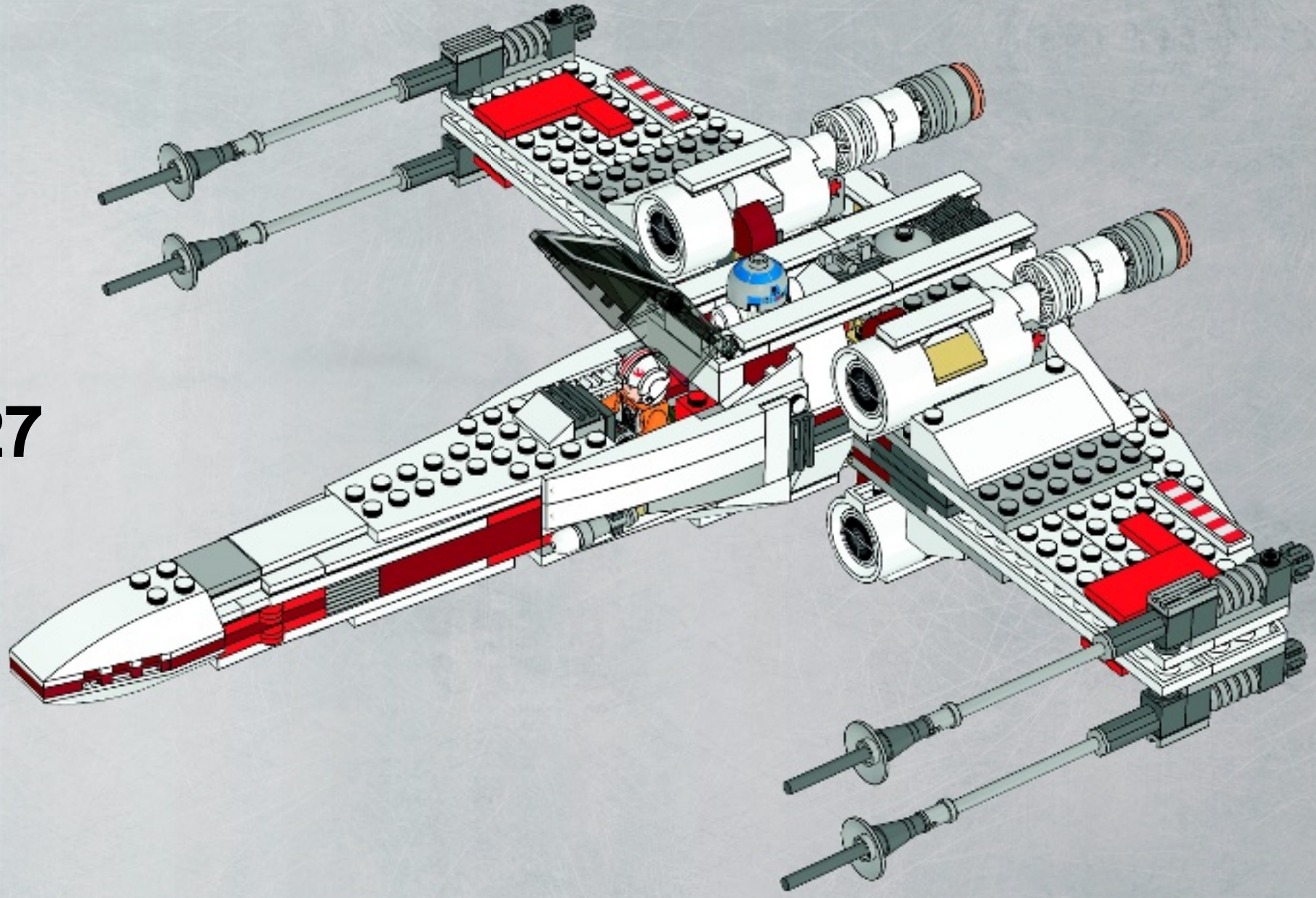



4x

28

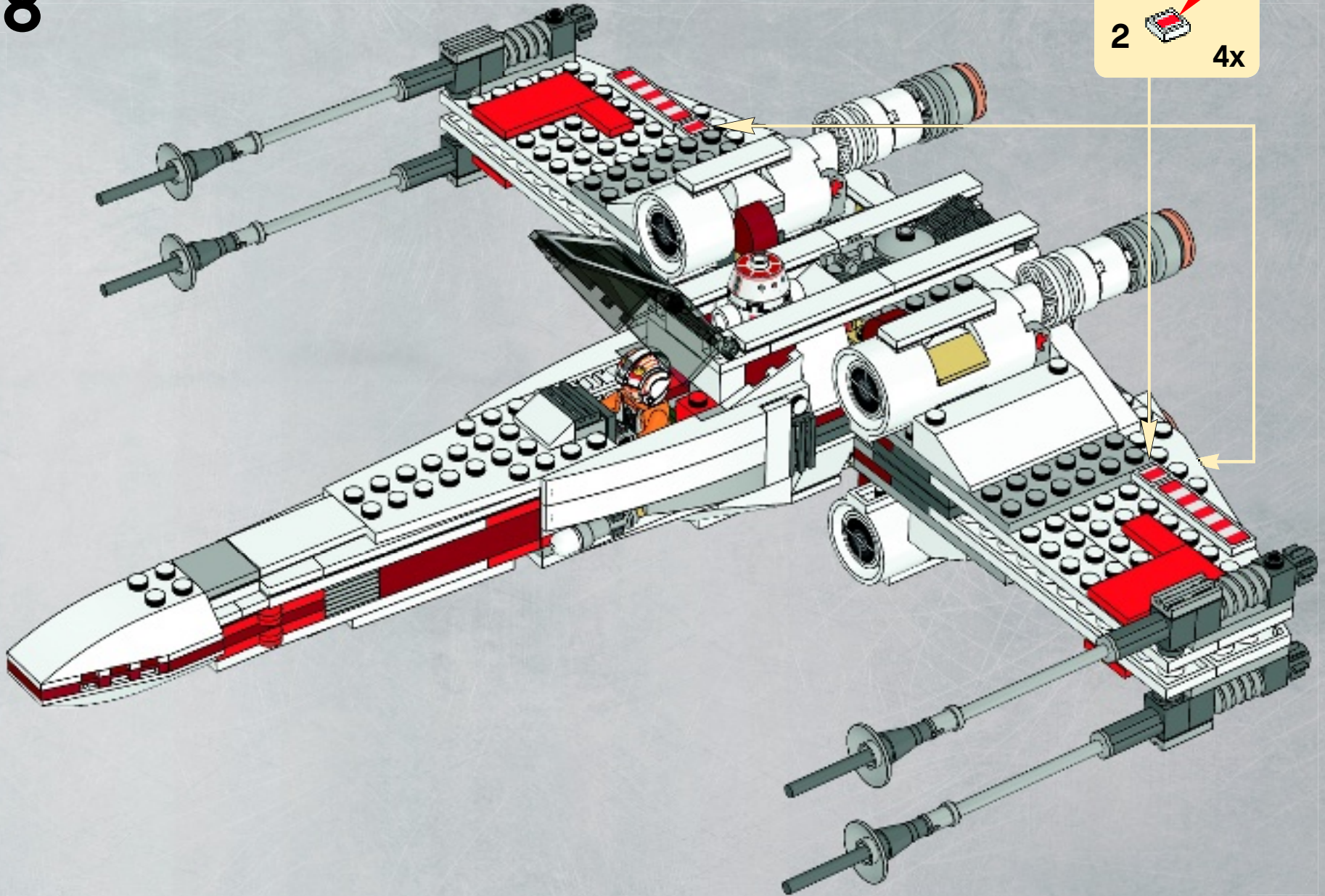

1



2



4x



Customer Service

Kundenservice

Service Consommateurs

Servicio Al Consumidor

www.lego.com/service or dial



00800 5346 5555 :

1-800-422-5346 :



- 4x 4211105
- 4x 4529240
- 12x 4210639
- 2x 4621917
- 1x 421054
- 2x 4211043
- 4x 4539429
- 2x 4211002
- 6x 4210997
- 2x 4579354
- 4x 4210631
- 1x 4514441
- 27x 4210633
- 4x 4211042
- 4x 4211010
- 8x 4538721
- 2x 4540386
- 4x 4211050
- 4x 4516546
- 2x 4508553
- 4x 4514559







9493



9492



9491



9490



9489



9488



9488



9489



9490



9491



9492



9493



9488



9489



9490



9491



9492



9493



9488



9489



9490



9491



9492



9493



9488



9489



9490



9491



9492



9493

ACE ASSAULT II



starwars.LEGO.com

LEGO club™

FREE! GRATIS! GRATUIT!



www.LEGOclub.com



LEGO® Club Magazine



LEGO® Club Email

SIGN UP ONLINE!
www.LEGOclub.com

VISIT THE WORLD'S
BIGGEST LEGO® SHOP!
www.LEGOshop.com

GO TO
www.LEGOclub.com

00800 5346 5555*

1-866-534-6258 • 1-877-518-5346

US & Canada only

Canada seulement



* Freephone. Mobile charges may apply. * Numéro sans frais. Des frais peuvent s'appliquer avec les téléphones cellulaires. * Gebührenfrei, Kosten für Anrufe aus Mobilfunknetzen können abweichen. * Gratis telefoonnummer vanaf vaste lijn. * Det er et gratis nummer, når du ringer fra fasttelefon. * Det är gratis, när du ringer från en fast telefon. * Numéro sans frais. Des frais peuvent s'appliquer avec les téléphones portables.



WIN!

Go to www.LEGOsurvey.com/product to fill out a survey for a chance to win a cool LEGO® Product.

No purchase necessary.

Open to all residents where not prohibited.



www.LEGO.com



www.LEGOsurvey.com/product

GEWINNE!

Nimm an der Umfrage auf www.LEGOsurvey.com/product teil und hab die Chance ein cooles LEGO® Produkt zu gewinnen!

Die Teilnahme am Gewinnspiel führt zu keinerlei Kaufverpflichtungen. Teilnahme in allen nicht ausgeschlossenen Ländern möglich.

WIN!

Ga naar www.LEGOsurvey.com/product, vul een enquêteformulier in en maak kans op een cool LEGO® product.

Geen aankoopverplichting. Iedereen mag deelnemen, uitgezonderd ingezetenden van landen waar een enquêteverbod geldt.

GAGNE!

Visite www.LEGOsurvey.com/product pour répondre à un questionnaire et avoir une chance de gagner un produit LEGO® très cool!

Aucune obligation d'achat. Ouvert à tous les résidents des pays autorisés.

当てよう!

www.LEGOsurvey.com/product にアクセスして、アンケートにご記入ください。当選者にはレゴ製品を差し上げます。

お買い上げの必要はありません。禁止されていない限り、すべての皆様にご利用いただけます。